

Multiprotocol Switched
Services (MSS) Server



Introduction and Planning Guide

Multiprotocol Switched
Services (MSS) Server



Introduction and Planning Guide

Note

Before using this information and the product it supports, be sure to read the general information under Appendix B, "Notices" on page B-1.

Third Edition (October 1997)

This edition applies to Version 2.0 of the 8210 Nways Multiprotocol Switched Services (MSS) Server and the Multiprotocol Switched Services (MSS) Server Module.

Order publications through your IBM representative or the IBM branch office serving your locality. Publications are not stocked at the address given below.

A form for readers' comments appears at the back of this publication. If the form has been removed, address your comments to:

Department CGF
Design & Information Development
IBM Corporation
PO Box 12195
RESEARCH TRIANGLE PARK NC 27709
USA

When you send information to IBM, you grant IBM a nonexclusive right to use or distribute the information in any way it believes appropriate without incurring any obligation to you.

© **Copyright International Business Machines Corporation 1996, 1997. All rights reserved.**

Note to U.S. Government Users — Documentation related to restricted rights — Use, duplication or disclosure is subject to restrictions set forth in GSA ADP Schedule Contract with IBM Corp.

Contents

About This Guide	vii
Who Should Read This Guide	vii
Related Publications	vii
How to Proceed	vii
8210 MSS Server Library	ix
A-MSS Server Module Library	x
MSS Server Library Overview	xi
Accessing the MSS Server Softcover Library	xi
Visit Our Web Sites	xii
Information Updates and Corrections	xii
Latest Switch Driver Images	xii
Online Support	xii
Summary of Changes	xii
Chapter 1. Introduction to the MSS Server	1-1
The MSS Server and ATM as a Networking Solution	1-3
Chapter 2. Functions of the MSS Server	2-1
Descriptions of the Functions	2-2
ATM Forum-Compliant LAN Emulation Service	2-3
Super VLAN Support	2-4
APPN Support	2-5
ATM Virtual Interfaces	2-5
BUS Performance	2-5
Enhanced FDDI to ATM Support	2-6
Quality of Service (QoS)	2-6
Next Hop Routing Protocol (NHRP) Support	2-6
Enhanced Routing and Bridging Support	2-6
Redundant ARP Server Support	2-6
Improved Redundant Default IP Gateway Function	2-6
Hardware Features	2-7
8210 PCMCIA Hard Disk	2-7
Data/Fax PCMCIA Modem and Voice/Data/Fax PCMCIA Modem	2-7
ATM MAC (ESI) Addresses	2-7
ATM MAC (ESI) Address of the 8210	2-7
ATM MAC (ESI) Address of the A-MSS Server Module	2-8
Management Using SNMP	2-8
Accessing MSS Server MIBs	2-9
Chapter 3. Physical Planning and Prerequisites	3-1
Placement Options	3-1
Tabletop Placement	3-1
Rack Placement	3-1
Hardware Requirements	3-1
Hardware and Software Requirements for the Configuration Program	3-2
Required Code Level for the ATM Control Point Switch Module	3-2
Physical, Electrical, and Environmental Specifications	3-2
Physical Specifications	3-2
Service Clearance	3-3
Power Requirements	3-3

Environmental Specifications	3-3
Over-Temperature Condition	3-3
Acoustic Characteristics	3-3
Pin Assignments for the EIA 232 Service Port	3-4
Pin Assignments for the Null Modem Cable	3-5
Ethernet Service Port	3-5
Planning the Cabling	3-5
Keeping a Record of the Network Topology	3-6
Chapter 4. Configuration and Monitoring Tools	4-1
Configuration Tools Overview	4-1
Command Line Interface	4-2
Configuration Program	4-3
Web Browser Hypertext Markup Language (HTML) Interface	4-4
Appendix A. Charts	A-1
Cabling Chart	A-1
Rack Inventory Chart	A-1
Appendix B. Notices	B-1
Electronic Emission Notices	B-1
Federal Communications Commission (FCC) Statement	B-1
Industry Canada Class A Emission Compliance Statement	B-1
Avis de conformité aux normes d'Industrie Canada	B-2
European Union (EU) Mark of Conformity Statement	B-2
Japanese Voluntary Control Council for Interference (VCCI) Statement	B-3
CISPR22 Compliance Statement	B-3
Taiwanese Class A Warning Statement	B-3
Trademarks	B-4
Glossary	X-1
Index	X-15

Figures

1-1. Front Panel of the IBM 8210 Nways Multiprotocol Switched Services (MSS) Server	1-2
1-2. Front of the Multiprotocol Switched Services (MSS) Server Module	1-2
3-1. EIA 232 Service Port Pin Assignments	3-4
3-2. Null Modem Cable Pin Assignments	3-5

Tables

3-1.	Declaration of IBM Product Noise Emission Values	3-4
3-2.	MSS Adapters and Cable Connectors	3-5
4-1.	Configuration Methods, Connections Supported, and Recommended Use	4-1

About This Guide

This guide describes the IBM Multiprotocol Switched Services (MSS) Server (MSS Server). There are two types of MSS Server: the IBM 8210 Nways MSS Server (8210), a standalone product, and the IBM Multiprotocol Switched Services (MSS) Server Module (A-MSS Server Module), which is installed as a module in the IBM 8260 Nways Multiprotocol Switching Hub (8260) or the IBM 8265 Nways ATM Switch (8265).

Note: Unless explicitly stated, the term *MSS Server* applies to both the 8210 and the A-MSS Server Module.

This guide discusses the functions of the MSS Server and provides physical planning guidelines and requirements for the installation of the MSS Server in your network. It also gives a brief overview of the tools used to configure, monitor, control, and maintain the MSS Server using the software that is provided with it.

Who Should Read This Guide

This guide is intended for network administrators who understand these characteristics of networks:

- Multiprotocol routing
- Bridging standards
- ATM standards

If you need education in these areas, IBM can help. Please contact your IBM representative for information about IBM networking education.

Related Publications

The following IBM publications offer additional information:

- *Understanding and Using the IBM MSS Server*, SG24-4915
- *8250/8260/8285 Planning and Site Preparation Guide*, GA33-0285
- *8265 Installation Guide*, SA33-0441
- *8265 User's Guide*, SA33-0456
- *8265 Command Reference Guide*, SA33-0458
- *8265 Media Module Reference Guide*, SA33-0459
- *8265 Planning and Site Preparation Guide*, SA33-0460

How to Proceed

The following steps document how to plan for and install your MSS Server. You should document all of the network information that will be required to install, connect, and configure the MSS Server.

Planning and Preparation

- 1 Become familiar with the capabilities of the MSS Server (See Chapter 1, "Introduction to the MSS Server.")
- 2 Determine which features and cables you will need. "Hardware Features" on page 2-7, describes the available

options. Design your network and place your order for your MSS Servers and cables. (Refer to “Planning the Cabling” on page 3-5 for a discussion on cables.)

- **3** Obtain and install the required LAN equipment and services.
- **4** Order and install any required cables not included with the MSS Server, such as ATM multimode and single-mode fiber cables that you will need to set up your network.
- **5** Obtain and install the hardware and software required to run the Configuration Program, as described in “Hardware and Software Requirements for the Configuration Program” on page 3-2.

Installation and Initial Configuration

- **1** Install the MSS Server using the *Installation and Initial Configuration Guide* provided with the product. (Alternatively, installation by IBM service personnel is available. Contact your IBM representative for additional information.)
- **2** Connect a terminal to the serial port or PCMCIA modem. This will enable you to do the initial configuration steps.
- **3** Access the MSS Server firmware to do initial configuration.
- **4** Run the “Quick Configuration” program to perform the initial configuration and activate your MSS Server. (Refer to the *Installation and Initial Configuration Guide*.)

Configuration

- **1** Perform final configuration. Refer to the *Multiprotocol Switched Services (MSS) Server Interface Configuration and Software User's Guide* and *Multiprotocol Switched Services (MSS) Configuring Protocols and Features* provided in softcopy with the product.

8210 MSS Server Library

Planning and Installation

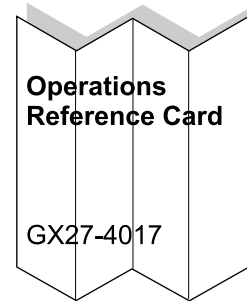
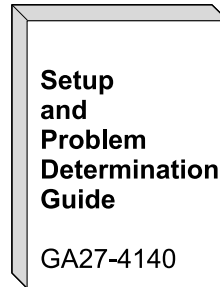

Configuration

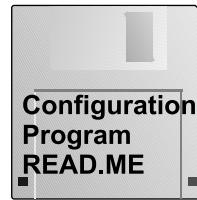
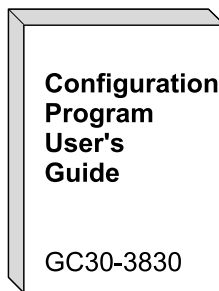

Diagnostics/Maintenance

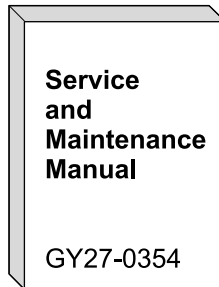

Operations and Network Administration

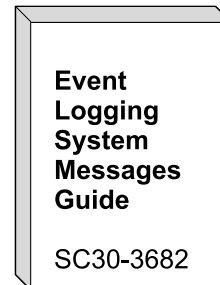
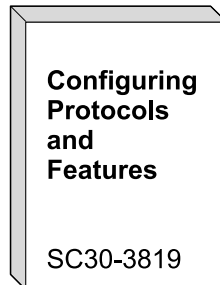
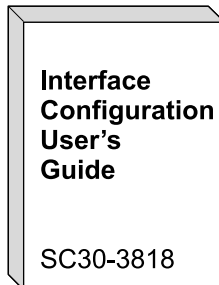

A-MSS Server Module Library

Planning and Installation

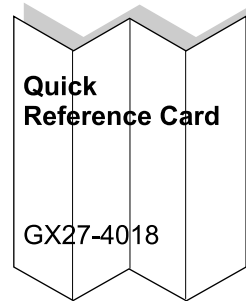
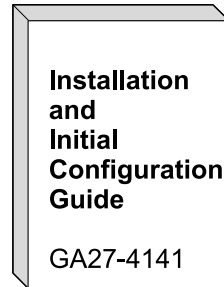
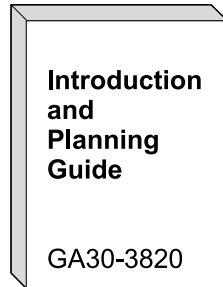

Configuration

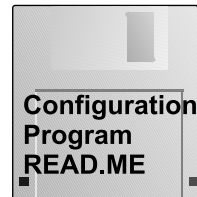
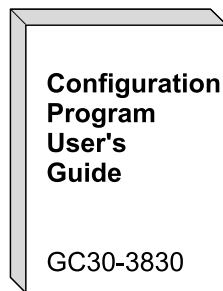

Diagnostics/Maintenance

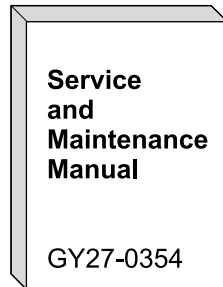

Operations and Network Administration

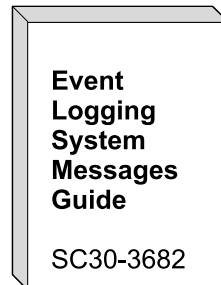
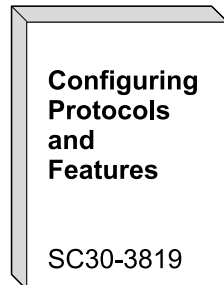
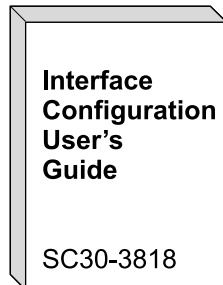

MSS Server Library Overview

The following IBM hardcopy publications are shipped with the product. The manuals in this list are also included in displayable softcopy form on the Multiprotocol Switched Services (MSS) Softcopy Library CD-ROM (SK2T-0378). This CD-ROM is shipped with initial orders for the MSS Server.

The reference cards and the safety information booklet are shipped in hardcopy only and are not included on the CD-ROM.

- *8210 Nways Multiprotocol Switched Services (MSS) Server Setup and Problem Determination Guide*, GA27-4140
- *8210 Nways Multiprotocol Switched Services (MSS) Server Operations Reference Card*, GX27-4017
- *Multiprotocol Switched Services (MSS) Server Module Installation and Initial Configuration Guide*, GA27-4141
- *Multiprotocol Switched Services (MSS) Server Module Quick Reference Card*, GX27-4018
- *CAUTION: Safety Information - Read This First*, SD21-0030

The following publications are not shipped in hardcopy, but are provided in softcopy form on the Multiprotocol Switched Services (MSS) Softcopy Library CD-ROM (SK2T-0378). All of these manuals (with the exception of the *Event Logging System Messages Guide*) can be separately ordered in hardcopy form through your IBM marketing representative.

- *Multiprotocol Switched Services (MSS) Server Introduction and Planning Guide*, GC30-3820
- *Multiprotocol Switched Services (MSS) Server Service and Maintenance Manual*, GY27-0354
- *Multiprotocol Switched Services (MSS) Server Interface Configuration and Software User's Guide*, SC30-3818
- *Multiprotocol Switched Services (MSS) Configuring Protocols and Features*, SC30-3819
- *Configuration Program User's Guide for Nways Multiprotocol Access, Routing and Switched Services*, GC30-3830
- *Event Logging System Messages Guide*, SC30-3682

Accessing the MSS Server Softcover Library

Important: Whether you choose to read the softcopy MSS Server publications directly from the CD-ROM or to upload the individual books to your hard disk, you first must install the Library Reader program (contained on the CD-ROM) on your workstation to enable you to view the publications.

The *Multiprotocol Switched Services (MSS) Server Softcopy Library* (included with the CD-ROM) describes how to install the Library Reader and how to access the softcopy books from a personal computer or PS/2 computer running DOS, Windows, or OS/2.

For alternative methods of managing your softcopy books, see the *Online Reference Online Library* that is on the CD-ROM.

Visit Our Web Sites

You can obtain the latest information on and support for the MSS Server by visiting our Web sites.

Information Updates and Corrections

To keep informed of engineering changes, clarifications, and fixes that are implemented after the manuals have been printed, refer to the IBM MSS Server home page at:

<http://www.networking.ibm.com/820/820prod.html>

Latest Switch Driver Images

To access updated versions of the MSS Server switch driver images, refer to the IBM Switch Driver Images page at:

<http://www.networking.ibm.com/nes/nesswitc.htm>

Online Support

To obtain support information and code for the MSS Server, refer to the IBM Network Environment Support page at:

<http://www.networking.ibm.com/nes/>

Summary of Changes

This manual has been revised to include the following changes and enhancements:

- Repackaging of the A-MSS Server Module to a one-slot 8260 module
- 166-MHz 603ev PowerPC processor for the A-MSS Server Module
- Addition of a 10BASE-T Ethernet service port to the A-MSS Server Module
- Replacement of the A-MSS Server Module's PCMCIA hard drive with an internal integrated drive electronics (IDE) hard disk
- Addition of an optional 20-MB flash drive for the A-MSS Server Module
- 64 MB of DRAM for both the 8210 and the A-MSS Server Module
- Extensions to the Next-Hop Routing Protocol (NHRP), allowing workstations and servers to make routing decisions (Zero-Hop Routing)
- Support for APPN, including dependent logical unit requester (DLUR), boundary access node (BAN), boundary network node (BNN), and high-performance routing (HPR) for both LAN emulation and native ATM support
- Ability to receive and transmit encapsulated bridge frames natively over ATM switched virtual circuits (SVCs)
- Support for Banyan VINES

The technical changes and additions are indicated by a vertical line (|) to the left of the change.

Chapter 1. Introduction to the MSS Server

The MSS Server is designed to support devices that run on ATM, including ATM-attached workstations, ATM bridges, and ATM LAN switches. In this environment, the MSS Server performs these three functions:

- LAN emulation
- Classical IP over ATM
- Routing and bridging support

There are two types of MSS Server: the IBM 8210 Nways Multiprotocol Switched Services (MSS) Server (8210), which is a standalone product, and the IBM Multiprotocol Switched Services (MSS) Server Module (A-MSS Server Module), which is installed as a module in the IBM 8260 Nways Multiprotocol Switching Hub (8260) or the IBM 8265 Nways ATM Switch (8265). The standalone version, the 8210, is connected to the ATM network over 155-Mbps optical fiber cable equipped with industry-standard SC connectors. The A-MSS Server Module connects to the ATM network when it is installed and made operational in the 8260 or the 8265.

The 8210 and the A-MSS Server Module have all the connectors and light-emitting diodes (LEDs) placed on the front.

Both the 8210 and the A-MSS Server Module have one standard serial service port: an EIA 232 male 9-pin D-shell connector. (In the A-MSS Server Module, the EIA 232 service port is identified as an RS-232 port.) The serial service port can be attached locally through a null modem cable or remotely through a modem attachment.

The A-MSS Server Module also has a 10BASE-T Ethernet service port.

In the U.S., Canada, and most other countries, the MSS Server is shipped with a Personal Computer Memory Card International Association (PCMCIA) modem.¹ This modem is provided so that you can access the MSS Server remotely to perform product configuration and maintenance. The MSS Server supports auto-answer for both the PCMCIA and the external modem attachment.

Figure 1-1 and Figure 1-2 show the fronts of each type of MSS Server.

¹ If you are not sure whether this feature is available in your country, see your IBM marketing representative.

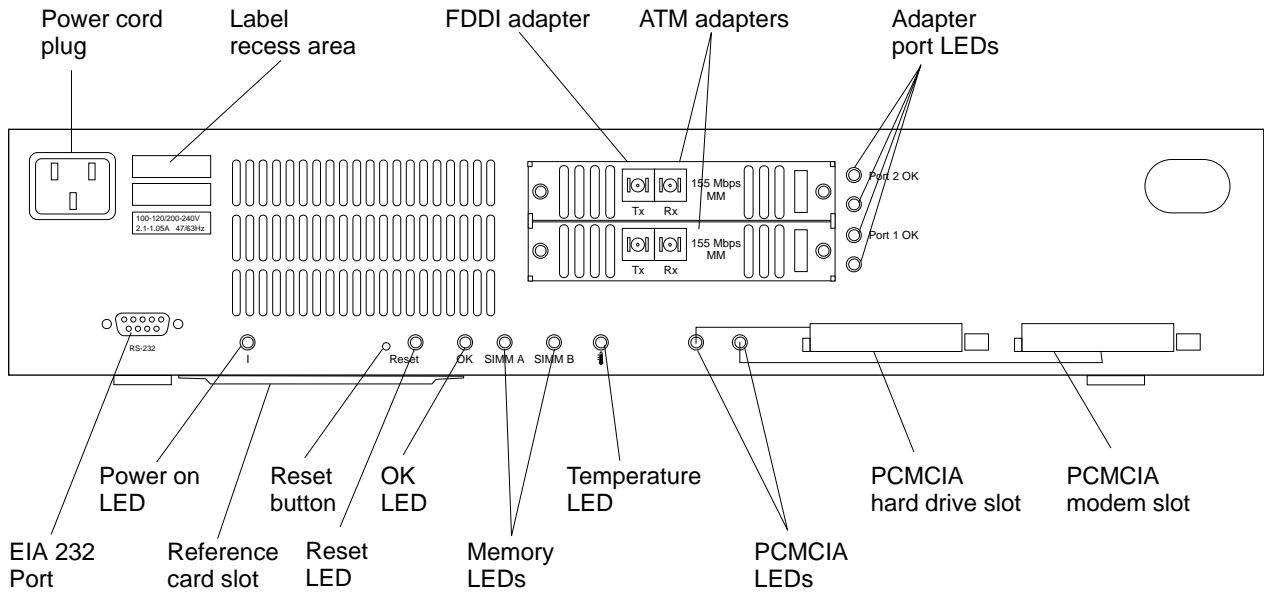

Figure 1-1. Front Panel of the IBM 8210 Nways Multiprotocol Switched Services (MSS) Server

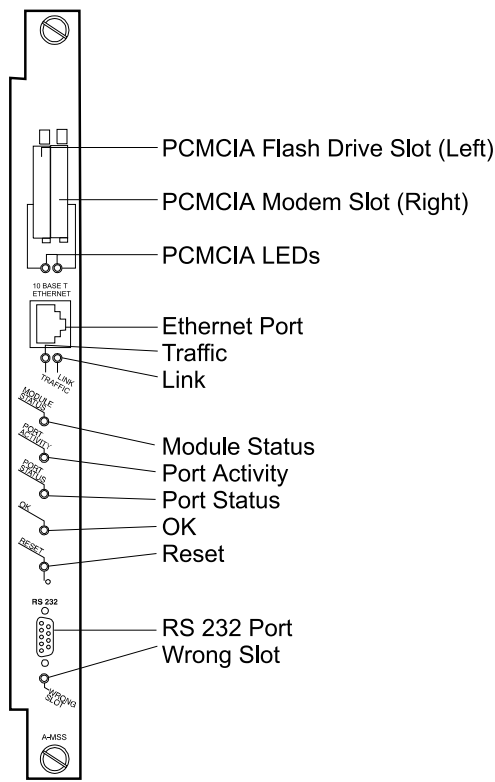

Figure 1-2. Front of the Multiprotocol Switched Services (MSS) Server Module

The MSS Server and ATM as a Networking Solution

The IBM Multiprotocol Switched Services (MSS) Server continues delivering ATM function that is a generation ahead of other ATM solutions.

If you are ready to update your current campus infrastructure, you will want to consider incorporating the MSS Server in an ATM network:

- Because of performance bottlenecks at routers
- When upgrading from current FDDI or 10-Mbps/16-Mbps backbone LANs
- When transforming your networks into an intranet
- When planning for new applications that have quality-of-service requirements such as voice and video applications

ATM has proven its ability to meet these demands in real-world networks. You will be interested in the MSS Server as part of your ATM solution because it provides a data infrastructure that scales from the smallest to the largest network. The MSS Server makes scalability a concern that ATM network managers no longer have to worry about by the announcement of **Super VLAN**.

The MSS Server microcode expands the capability of the ATM network in terms of scalability, reliability, performance, adaptability, and connectivity. The MSS Server can transform an ATM network into a superhighway that is superior to any other type of LAN technology or data network.

The MSS Server provides the highest level of network performance by allowing an ATM network to switch the data from end to end without having to process frames at intermediate stops along the way. It provides reliability by eliminating single point of failure. MSS is designed to provide redundancy of every networking function.

Chapter 2. Functions of the MSS Server

The MSS Server acts as a LAN emulation server and a server for Classical IP over ATM. It enables you to create emulated LANs (ELANs) and virtual IP subnetworks. Its bridging and routing functions can connect these virtual LANs as if they were physical LANs, IP subnetworks, or IPX subnetworks.

The MSS Server provides ATM campuses with the following services:

- Support for the following adapters:
 - 155-Mbps multimode fiber ATM
 - 155-Mbps single-mode optical fiber ATM
 - Dual-ring optical fiber FDDI

You can choose from among these connections to select the one that works best for your ATM switch and environment.

- ATM Forum-compliant and IBM LAN emulation service, including support for both Ethernet emulated LANs and Token-Ring emulated LANs. LAN emulation allows ATM networks to appear as LANs. Using LAN emulation, devices that are connected to existing LANs and devices that are connected to the ATM network can belong to the same emulated LAN (ELAN) and use existing LAN applications.

Devices included in emulated LANs are organized according to their logical groupings rather than their physical locations. Therefore, when a device in an ELAN or a virtual IP subnet is moved or added to the network, you do not have to provide it with new addresses.

- Enhanced LAN emulation broadcast management support for IP, Novell IPX, NetBIOS, and source route bridge broadcasts. Reducing broadcasts reduces the traffic on the network and allows better performance and scalability.
- Enhanced LAN emulation fault tolerance, supporting multiple redundant LAN emulation servers with automatic recovery in case of failure.
- Support for Banyan VINES.
- Support for backup LAN emulation service components.
- The following types of bridging support:
 - Source routing bridging (SRB)
 - Transparent bridging (TB)
 - Source route transparent bridging (SRT)
 - Source route to transparent bridging (SR-TB). SR-TB is supported only for protocols that use IEEE 802.2 logical link control (such as SNA and NetBIOS).
 - Source route and transparent bridging without translation
 - Adaptive source route transparent bridging (ASRT). This is SRT bridging combined with SR-TB. In this type of bridging, source-routed traffic can be converted to transparent bridge format. The conversion is not part of the SRT standard.
 - Dual Spanning Tree support
- Standards-based IP routing support on ATM, including support for Classical IP and routing between an ELAN and Classical IP.

- Standards-based Novell IPX routing support on ATM between emulated LANs. IPX routing is supported over emulated LAN interfaces and RFC 1483¹ connections to other routers. The IP and IPX protocols treat emulated interfaces implemented by LAN emulation clients (LECs) just like real Ethernet and Token-Ring interfaces.
- Super LANE for Ethernet ATM emulated LANs (SuperELAN)
- FDDI routing for connection to FDDI to ATM
- Quality of Service (QoS) for ATM emulated LANs
- Next Hop Routing Protocol (NHRP) support for reduction of routing hops
- AppleTalk routing support
- Support for RFC 1483 bridging format
- Improved Broadcast Manager (BCM) for larger IPX networks
- Redundant ARP Server support
- Improved redundant IP gateway function

Descriptions of the Functions

The functions include ATM Forum-compliant LAN emulation service, as well as IBM LAN emulation services; Classical IP over ATM; and standards-based bridging and routing support.

As a pioneer of ATM technology, IBM defined one of the early LAN Emulation architectures. When the ATM Forum released its final ATM Forum LAN Emulation Specifications, they diverged in a number of ways from the IBM architecture. Consequently, IBM, like several other vendors, now has products that implement two different LAN Emulation architectures: some earlier products implement the IBM LAN Emulation Architecture, while other more recently developed products implement the ATM Forum LAN Emulation Specification. By adding a client for the IBM LAN Emulation Architecture, the MSS Server can provide routing and bridging services that support both purposes.

From routing and bridging perspectives, IBM LECs are functionally equivalent to ATM Forum LECs; both provide emulated Ethernet and Token-Ring interfaces with operational characteristics of real interfaces. You can configure a LEC to be any of these types:

- Ethernet IBM
- Ethernet Forum-Compliant
- Token-Ring IBM
- Token-Ring Forum-Compliant

¹ J. Heinanen, "Multiprotocol Encapsulation over ATM Adaptation Layer 5," RFC 1483, Telecom Finland, July, 1993.

ATM Forum-Compliant LAN Emulation Service

This function allows ATM networks to appear as LANs to provide a migration path to ATM that protects your investment in current LAN hardware and software. The MSS Server supports both Ethernet and Token-Ring ELANs. Routable protocols such as IP and IPX and non-routable NetBIOS can both be run over ELANs.

By providing ATM Forum-compliant LAN emulation, the MSS Server offers you the opportunity to connect ATM devices with Ethernet or Token-Ring devices. You can protect your investment in LAN hardware and applications when you add an ATM backbone to your network. As your network expands, you can continue to add ATM devices and gradually migrate to ATM.

Emulated LANs are not based on physical topology (like existing shared-media LANs) but are logical groupings of end stations. Having the stations logically grouped allows much greater flexibility in handling moves, additions, and changes of the end stations.

Enhanced LAN Emulation Functions

In addition to ATM Forum-compliant LAN emulation, the MSS Server offers several enhanced LAN emulation features that improve network security, manageability, and performance.

Security: The MSS Server offers additional security when emulated LANs are established. The LAN emulation configuration server (LECS) can be used to check that a workstation that is attempting to join an ELAN belongs in that ELAN. This function helps to prevent unauthorized workstations from being admitted to an ELAN.

Redundancy: Through IBM extensions of LAN emulation, the MSS Server can provide both redundant and a distributed LAN Emulation Server. A redundant server remains in a backup state until the failure of a primary server. With the distributed service provided by the SuperELAN functions of the MSS Server, multiple LAN Emulation Servers can serve an ELAN simultaneously, providing both load balancing and reliability.

Performance—Enhanced LAN Emulation Broadcast Management: The broadcast management function is an IBM enhancement to LAN emulation. When explicitly enabled through configuration, Broadcast Manager (BCM) processes certain types of broadcast frames and, whenever possible, sends them only to interested LAN emulation clients and end stations. By reducing broadcast frames, Broadcast Manager reduces traffic on the network, reduces the overhead incurred on each end station, and thus enables better performance and scalability.

Manageability—BUS Monitor: Monitor is a function in the MSS Server that provides a mechanism to pinpoint end users who could be overutilizing the Broadcast and Unknown Server (BUS). Such overuse may be due to faulty software or hardware, or may be intentional abuse of network resources. When enabled, BUS Monitor periodically samples the BUS traffic that occurs on a particular ELAN. At the end of each sample interval, the BUS Monitor identifies the top users of the BUS by their source MAC addresses, LEC ATM addresses, and the number of sampled frames each of them has sent to the BUS. This information can be retrieved using SNMP or the monitoring functions found in the command line interface and in the Web browser interface.

Classical IP over ATM

The MSS Server supports Classical IP over ATM as specified in RFC 1577. It also supports RFC 1755 for signaling support and RFC 1483 for packet encapsulation. ATM devices on the network are configured with IP subnet addresses as logical IP subnets (LISs). The MSS Server provides IP routing between the LISs.

Standards-Based Bridging and Routing Support

The MSS Server supports six bridging techniques (source route bridging, transparent bridging, source route transparent bridging, source route and transparent bridging, source route to transparent bridging, and adaptive source route transparent bridging).

The extensive IP routing implementation of the MSS Server includes OSPF, multicast support, Border Gateway Protocol-4 (BGP-4), and classless addressing in addition to basic IP support like ICMP, UDP, TCP, ARP, and RIP.

The MSS Server IPX routing support complies with the IPX Router Specification from Novell. IPX is supported over emulated LANs. Connection to other IPX routers is supported over ATM, as described in RFC 1483.

With its wide variety of bridging and routing support, the MSS Server protects your investments in existing networking equipment and provides a migration path to ATM. The bridging and routing support also allows emulated LANs to be partitioned for better manageability. The MSS Server can enable Ethernet and Token-Ring ELANs to communicate with one another and with Classical IP LISs. Using the MSS Server, you can create and manage a network composed of shared-media LANs, switched LANs, and ATM devices.

The MSS Server supports the migration of SNA networks to ATM by providing a LAN emulation environment for transport of SNA over ATM. Where the ATM network is divided into more than one emulated LAN, the MSS Server bridges SNA from between the emulated LANs.

For a more detailed description of the functions of the MSS Server, refer to the *Multiprotocol Switched Services (MSS) Server Interface Configuration and Software User's Guide*.

Super VLAN Support

Super VLAN is a collection of emulated LANs that allows you to build large ATM networks. A client on any of the emulated LANs can establish a direct link, a data direct VCC, to any other client on the super VLAN. In essence, the super VLAN is emulating a standard ELAN, except that the LAN Emulation Server (LES) function is distributed throughout the ATM network. Reliability and performance of the LE services increase with the number of service entities. Resource utilization becomes less centralized, allowing for a much larger super VLAN than a standard ELAN.

This distribution of LE services does not rely on a proprietary communications protocol between service entities. Instead, it is accomplished by an extension to transparent bridging called "Short-Cut Bridging." A *short cut bridge (SCB)* forwards certain LAN emulation control frames between SCB ports. Control frame forwarding allows clients attached to distinct LESs to establish data direct VCCs to each other.

Two functions are added to SCB to complete the Super VLAN function: *Bridging Broadcast Manager (BBCM)* and *Dynamic Protocol VLANs (D-PVLANS)*. BBCM and D-PVLANS are added to control the broadcast traffic that would otherwise limit the effectiveness of a large emulated LAN. BBCM, like Broadcast Manager (BCM) in a single emulated LAN, resolves Layer 3 broadcasts into a Layer 2 unicast frame. D-PVLANS on the other hand, keeps track of what protocols and what subnets are on each of the LES domains. When BBCM is unable to resolve a broadcast, D-PVLANS forwards it only to those segments that are interested. D-PVLANS partitions the super VLAN into protocol-specific ELANS.

SCB is for Transparent Bridging only. It will support both Token-Ring and Ethernet emulated LANs.

APPN Support

The MSS Server contains the same APPN functions as the IBM 2216 Nways Multiaccess Connector, except for those functions that are not applicable to an ATM environment. Key APPN functions are::

- Dependent logical unit requester (DLUR)
- Boundary access node (BAN)
- Boundary network node (BNN)
- High-performance routing (HPR)

The HPR support is for both LAN Emulation and for native ATM support. The MSS Server provides the ability to receive and transmit encapsulated bridged frames natively over ATM Permanent Virtual Circuits (PVCs), requiring that the PVCs be set up in all the intermediate switches. The MSS Server also extends this capability to Switched Virtual Circuits (SVCs). Bridge ports are configured with a destination ATM address; no switch configuration is necessary.

ATM Virtual Interfaces

Currently only 32 protocol addresses can be configured on any single interface. This function eliminates this limitation. When more protocol interfaces are needed on a physical interface, additional virtual interfaces can be defined on the physical interface. To the protocol support in the MSS Server, a virtual interface looks just like an additional adapter, and 32 addresses can be assigned to each virtual interface.

This function can actually improve the performance in large, complicated networks and aids multicast routing protocols, such as OSPF.

BUS Performance

In LAN emulation, BUS performance determines the ability of ATM to forward frames for which a data direct VCC has not been established. The MSS Server increases the number of frames forwarded to over 100 Kpps in the standard BUS configuration.

Enhanced FDDI to ATM Support

The MSS Server adds support for dual-ring fiber FDDI which allows you to route IP, IPX, and AppleTalk traffic between FDDI and ATM networks.

Quality of Service (QoS)

One of the advantages of ATM is the ability to negotiate *Quality of Service (QoS)*. The MSS Server provides the ability to define a QoS for a LAN Emulation Client (LEC), an emulated LAN, or an ATM interface.

Next Hop Routing Protocol (NHRP) Support

The MSS Server also provides one of the main functions of the expected Multiprotocol Over ATM (MPOA) standard—*Next Hop Routing Protocol (NHRP)*. This function allows NHRP clients to set up a data direct VCC and forward IP data frames without traversing intermediate routers.

Enhanced Routing and Bridging Support

The MSS Server provides routing support for AppleTalk and bridging support for RFC 1483 bridge format frames.

Redundant ARP Server Support

Two MSS Servers can act as redundant ARP servers. You can configure which MSS Server will act as the Primary ARP server, and which will act as the Secondary ARP server. If both MSS Servers are active, the primary will always be the one to service incoming calls.

Improved Redundant Default IP Gateway Function

This function allows end stations with manually configured default gateway IP addresses to continue passing traffic to other subnets after their primary gateway goes down. Without a backup gateway, an end station with a manually configured default gateway address is unable to send packets to other subnets until either the gateway comes up or the user changes the default gateway address.

Hardware Features

The following table shows the features available with the 8210 and the A-MSS Server Module.

Description	Machines	Models	Features
IBM 8210 Nways Multiprotocol Switched Services (MSS) Server	8210	001	
A-MSS Server Module	8260/8265		5400
Service kit	8210		2505
1-port 155-Mbps multimode fiber ATM adapter	8210		3001
1-port 155-Mbps single-mode fiber ATM adapter	8210		3002
Dual-ring fiber FDDI adapter	8210		4001
64-MB upgrade kit	8210/8260/8265		5301
8210 MSS Server Model 001 Microcode V1	8210/8260/8265		8706
MSS Microcode V2	8210/8260/8265		8707
8210 MSS Server Model 001 260-MB PCMCIA hard disk	8210		8708
MSS Microcode upgrade V1 to V2	8210/8260/8265		8709
MSS flash drive	8260/8265		8711

8210 PCMCIA Hard Disk

The PCMCIA hard disk is a required hardware element of the 8210 that is shipped with the product.

Data/Fax PCMCIA Modem and Voice/Data/Fax PCMCIA Modem

This interface is intended for remote installation, network management, and service access to the MSS Server. The Voice/Data/Fax PCMCIA modem is available only in the U.S. and Canada. The Data/Fax PCMCIA modem is available in most countries. The Voice/Data/Fax Modem is shipped with the MSS Server in the U.S. and Canada; the Data/Fax Modem is shipped with the MSS Server in other countries, unless the modem is not available in your country. See your IBM representative for more information.

ATM MAC (ESI) Addresses

The media access control (MAC) address, also called the end system identifier (ESI), is a unique identifier that is 6 bytes long. If you use the ESI that is assigned to the ATM device interface at the factory, you are using the *burned-in* or *universally administered* address.

ATM MAC (ESI) Address of the 8210

This address has the following range of values for the 8210:

```
B'0000 0000 0000 0100 1010 1100 0100 0111 0000 0000 0000 0000'
```

The first four bytes are fixed in value. The last two bytes are assigned by the factory.

In most significant byte (MSB) form this address block begins with :

X'00 04 AC 47'

In canonical form, this address block begins with:

X'00 20 35 E2'

The bits are to be delivered to or received from the physical medium in the order written above, with the leftmost bit first.

ATM MAC (ESI) Address of the A-MSS Server Module

This address has the following range of values for the module:

B'0000 0000 0000 0100 1010 1100 1001 1001 0000 0000 0000 0000'

The first four bytes are fixed in value. The last two bytes are assigned by the factory.

In most significant byte (MSB) form this address block begins with :

00 04 AC 99

In canonical form, this address block begins with:

00 20 35 99

The bits are to be delivered to or received from the physical medium in the order written above, with the leftmost bit first.

Management Using SNMP

The MSS Server network management support is based on the following functions of Simple Network Management Protocol (SNMP):

- SNMP version 1 protocol
- Transportation of SNMP messages between MSS Servers and network management stations (NMSs)
- Configurable MIB information access
- A comprehensive set of standard and enterprise-specific SNMP MIBs for monitoring and managing resources
 - Bridging and Routing
 - Emulated LAN (ELAN) services (LAN Emulation Server [LES], Broadcast and Unknown Server [BUS], and LAN Emulation Configuration Server [LECS])
 - Broadcast Manager
 - System specific
 - Enterprise specific
 - LAN Emulation Client (LEC)
 - Interim Local Management Interface (ILMI) Extensions
 - ATM interfaces—AToM

The SNMP agent in the MSS Server uses a simple authentication scheme to determine which Network Management Station can access which portion of the MIB data. The user defines the *Community Name* by specifying a set of IP addresses (using an IP mask) that has the same access privilege (read-only, read-write) to the same subset of the MIB data (*MIB view*). The Community Name is included in each SNMP message and is verified by the MSS Server SNMP agent.

Users can configure the trap destination and associated filtering.

Accessing MSS Server MIBs

All of network management data is available via SNMP. The MIB contents for SNMP are listed below.

Function	MIB Information
General	RFC 1213 (MIB-II) RFC 1573 (Interface MIB)
ATM Interfaces	RFC 1695 (AToM MIB)
LAN Emulation Server	LE Services Mgmt V1.0
LAN Emulation Client	LE Client Mgmt V1.0
RFC 1493 (Bridges) RFC 1525 (Source Route Bridges)	
Routing Protocols	RFC 1253 (OSPF) Novell IPX and RIP/SAP MIBs RFC 1213 (MIB-II)
Others	Routing Enterprise (e.g., ELS) MSS Specific Broadcast Manager

MIBs supported by the MSS Server are accessible through the Internet using anonymous FTP at

venera.isi.edu, ds.internic.net

and

nways.raleigh.ibm.com

The suggested location to obtain MIBs and information is

nways.raleigh.ibm.com

Along with product and release-specific network management information, all attempts have been made to correct errors in the MIBs and to fix any problems when loading MIBs into a network management station.

Note: If you run into problems accessing `nways.raleigh.ibm.com`, try the "alias" address, `6611ftp.raleigh.ibm.com`, or IP address `204.146.167.70`. However, the IP address may change without notice, so try the host names first.

1. To connect to the various FTP servers, enter the appropriate command:

```
For various enterprise MIBs      -- %ftp venera.isi.edu
For RFC defined MIBs            -- %ftp ds.internic.net
For MIBs and information        -- %ftp nways.raleigh.ibm.com/mss
```

At the name prompt, enter **anonymous**. You will be prompted for a password. Enter your internet mail address.

2. Change to the MIBs directory by entering:

```
For various enterprise MIBs      -- %cd /mib
For RFC defined MIBs            -- %cd /rfc
For MIBs and information        -- %cd /pub/netmgmt
```

3. To receive a copy of a specific MIB, enter the **get** command together with the name of the MIB. As an example:

|

```
For MIB defined by number #### -- % get rfc####.mib
-- % get ibmMSS8210.mib
-- % get novell-ipx.mib
-- % get novell-rip-sap.mib
```

Using this command places a copy of the specified MIB in the directory from which you connected to the FTP server.

Chapter 3. Physical Planning and Prerequisites

This chapter describes physical characteristics of the 8210 MSS Server. Some information applicable to the A-MSS Server Module is not included because the module fits into the 8260 or 8265. To install the A-MSS Server Module, you need to plan for the 8260 or 8265. Refer to the *8250/8260/8285 Planning and Site Preparation Guide* or the *8265 Planning and Site Preparation Guide* for hub planning information.

The only cables attached to the A-MSS Server Module are the cables attached to the EIA 232 and Ethernet service ports and the cable attached to the PCMCIA modem, if it is used. Installing the A-MSS Server Module in the 8260 or 8265 and making it operational establishes the connection to the ATM network.

Placement Options

The 8210 MSS Server can be placed on a tabletop or in a rack.

Tabletop Placement

If the 8210 MSS Server is placed on a tabletop, the table must meet the requirements for service and operating clearances listed under "Physical, Electrical, and Environmental Specifications" on page 3-2.

Rack Placement

If you choose rack-mounting, you must provide the rack; it is not provided with the 8210 MSS Server.

You can use any EIA standard 19-inch rack. The rack can be open or closed. However, if you choose a closed rack, you must make sure that enough air flows through the 8210 MSS Server. Covers on the front of the rack that would not let air reach the 8210 MSS Server must be removed or modified to let air pass. Similarly, unvented rear rack covers that would not let air exit the 8210 MSS Server or that would cause back pressure to build up from several machines must not be used.

The attachment holes along each side of a rack are usually divided into units of measure called *EIA units* (U). Each EIA unit equals 44.5 millimeters (1.75 inches). The 8210 MSS Server is approximately 2U (92.1 mm [3.63 in.]). There is no requirement for clearance between 8210 units in a rack; multiple units can be spaced 2U apart.

Hardware Requirements

You must provide the following hardware to operate the MSS Server:

- The appropriate adapter cable to attach the MSS Server to the ATM switch. See "Planning the Cabling" on page 3-5 for a list of IBM cable feature numbers.
- A modem for the MSS Server for some MSS Server functions. In most cases, this is a PCMCIA modem that is provided with the initial MSS Server order. In some countries, the modem is not available. Your IBM representative can tell you whether you will receive the modem. If the modem is not shipped with

your MSS Server, you will have to supply a modem that connects to the serial port. The modem must support the AT command set and one of the following protocols:

ITU-T V.32 at 9.6 Kbps
ITU-T V.32 bis at 14.4 Kbps
ITU-T V.34 at 28.8 Kbps

Whether you use the IBM modem or provide your own modem, you must set up a communications (telephone) line to the modem to use it. A workstation is required to access the MSS Server.

The required operational software is shipped preloaded on each MSS Server.

Hardware and Software Requirements for the Configuration Program

You can use the Multiprotocol Switched Services Configuration Program (configuration program) to prepare configuration files and then upload them to the MSS Server. This method of configuration enables you to use the change management functions of the MSS Server.

Note: Using the configuration program is recommended for the initial configuration of the MSS Server. The configuration program enables you to save and track configuration files. You can also make an ASCII copy of the completed configuration file to check its parameters before you download it to the MSS Server.

Refer to *Configuration Program User's Guide for Nways Multiprotocol Access, Routing and Switched Services* for details of hardware and software operating environments in which the program will operate.

Required Code Level for the ATM Control Point Switch Module

Attention: For users of the A-MSS Server Module: After you physically install the A-MSS Server Module in the hub, you must connect the ATM backplane and enable the ATM backplane using the ATM Control Point Switch Module (CPSW). The CPSW must be at code level 2.5.2, or higher, in order for the hub to correctly recognize the module and enable its LEDs.

Physical, Electrical, and Environmental Specifications

Physical Specifications

Width	440 mm (17.3 in.) without rack-mounting flanges 480 mm (18.9 in.) with rack-mounting flanges
Depth	358 mm (14.1 in.)
Height	92.1 mm (3.63 in.) from the top of the 8210 MSS Server to the top of the next machine that is mounted in the rack
Weight	6.7 kg (14.7 lb) with two ATM Adapters

Service Clearance

The 8210 MSS Server can be rack- or surface-mounted. It should have at least 100 mm (4.0 in.) minimum clearance at the rear and 300 mm (11.8 in.) clearance at the front. The air flow for ventilation is from front to back.

Power Requirements

Electrical power	0.107 kVA
Starting current	less than 40 A
Leakage current	1.5 mA maximum

The ac power cord connector is in the front of the 8210 MSS Server. The 8260 or 8265 supplies power to the A-MSS Server Module.

Environmental Specifications

Power-on temperature	10°C—40°C (50°F—104°F)
Storage temperature	1°C—60°C (33°F—140°F)
Relative humidity	8%—80%
Max. wet bulb	27°C (81°F)
Heat output	46.5 Kcal/hr (184 BTU/hr)
Capacity of exhaust	0.566 m ³ /min. (20 cubic ft/min.)
Noise level	44 dB

Over-Temperature Condition

If the temperature in the 8210 MSS Server approaches the maximum operating (power-on) temperature, the operational code issues a warning message. If the temperature in the 8210 MSS Server exceeds the maximum operating temperature and thermal shutdown is enabled, the over-temperature LED will come on, and the 8210 MSS Server will shut down. The 8210 MSS Server will restart when the temperature inside the 8210 MSS Server returns to the operating range.

An over-temperature condition could indicate that the cooling fans have malfunctioned or an abnormally high room temperature where the 8210 MSS Server is located.

Acoustic Characteristics

The following table is a declaration of the MSS Server noise emission characteristics.

Table 3-1. Declaration of IBM Product Noise Emission Values

Type	Description	LwAd		LpAm		<LpA>m	
		Operating (bels)	Idle (bels)	Operating (dB)	Idle (dB)	Operating (dB)	Idle (dB)
8210	MSS Server	4.8	4.8	N/A	N/A	44	44

Notes:

- LwAd is the declared (upper limit) sound power level for a random sample of machines.
- LpAm is the mean value of the A-weighted sound pressure levels at the operator position (if any) for a random sample of machines.
- <LpA>m is the mean value of the A-weighted sound pressure levels at the 1-meter (bystander) positions for a random sample of machines.
- N/A Indicates "not applicable" (that is, having no defined operator position.)

All measurements were made in accordance with ANSI S12.10 and reported in conformance with ISO DIS 9296.

Pin Assignments for the EIA 232 Service Port

Both the 8210 MSS Server and the A-MSS Server Module have a standard, EIA 232 service port: a male 9-pin D-shell connector. It can be attached locally through a null-modem cable, or remotely through a modem attachment. The service port is provided so that you can access the MSS Server to perform configuration or maintenance. The line speed is 19.2 Kbps.

Figure 3-1 shows the pin assignments for the service port connector. Connectors for the MSS Server and the A-MSS Server Module are identical.



Figure 3-1. EIA 232 Service Port Pin Assignments

Pin Assignments for the Null Modem Cable

Figure 3-2 shows the pin assignments for the null modem cable.

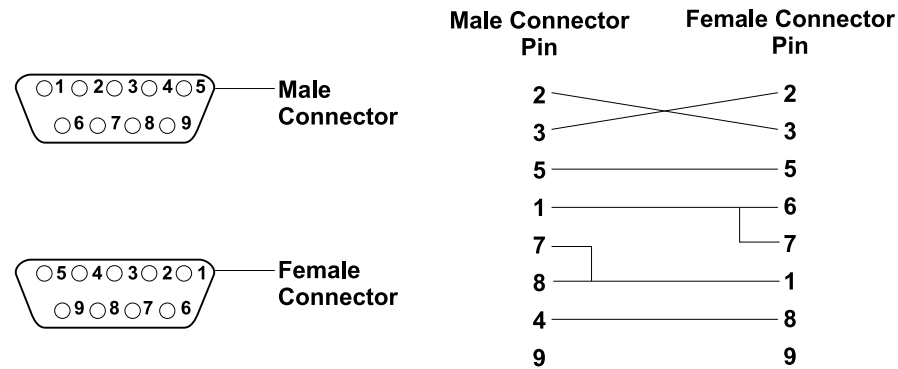

Figure 3-2. Null Modem Cable Pin Assignments

Ethernet Service Port

In addition to the EIA 232 service port, the A-MSS Server Module has an additional service port: a 10BASE-T Ethernet port.

Planning the Cabling

Cables are not provided with the 8210 for ATM adapters or FDDI adapters and they must be ordered separately. Refer to the following table for information about cables and adapters for the MSS Server.

Table 3-2. MSS Adapters and Cable Connectors

Adapter	Feature Code	Cable Type	Connector Type
ATM 155-Mbps multimode fiber	3001	62.5-micron, plenum-rated multimode fiber	Industry-standard SC
ATM 155-Mbps single-mode fiber	3002	9-micron, plenum-rated single mode fiber	Industry-standard SC
FDDI dual-ring optical fiber	4001	62.5-micron, plenum-rated multimode fiber	Industry-standard SC

Note: ATM and FDDI adapter cables are not provided and must be separately purchased. You can order them through your IBM representative.

If you plan to use the EIA 232 service port, you must provide a cable, and it must be correctly shielded and grounded. This MSS Server service port provides an EIA 232-D with a 9-pin D-shell male connector.

If you plan to use the Ethernet service port, you also must provide a 10BASE-T cable. This MSS Server service port provides a 10BASE-T Ethernet connector.

Keeping a Record of the Network Topology

On appropriate charts, floor plans, and other network documentation, you should record the location and identification of:

- Each device in your network. The identification can consist of its MAC address and other addresses, for example, ATM address and IP address.
- The cable numbers and their connection points at the MSS Server connectors and at the next network device.
- The cable numbers and the cable connection points from that network device to the next, and from that device to the next, if applicable

In addition to the physical map of your network, you can record the logical structure of the network. This information identifies the emulated LANs (ELANs) or the logical IP subnets (LISs) to which each device belongs.

Chapter 4. Configuration and Monitoring Tools

Access to the MSS Server is provided to enable you to install the operational software and to configure, monitor, control, and maintain the product using software that is provided with it.

Configuration Tools Overview

You can use one (or a combination) of three methods to configure the MSS Server:

- Command line interface
- Configuration Program (also known as the GUI or graphical user interface)
- Web browser

Table 4-1 provides a summary of the three configuration methods.

Table 4-1. Configuration Methods, Connections Supported, and Recommended Use

Method	Connections Supported				Recommended Use
	TTY	SLIP	Ethernet	ATM	
Command Line Interface	X	X	X	X	The basic interface. Can be used to create partial or full configuration. Not as easy to use as the other methods.
Configuration Program		X	X	X	Easy to use. Can be used to create a full configuration. However, because the configuration must be downloaded, the command line interface must be used to make changes.
Web Browser		X	X	X	An easy-to-use HTML/HTTP interface that provides access to the MSS Server's configuration and console functions, including Quick Configuration and an extensive subset of the functions provided by the command line interface. Functions that cannot be accessed are the firmware functions and some of the GWCON and Config functions (for example, PING).

The following sections describe when to use each method, explain the advantages and disadvantages of each method, and tell you where to find additional information.

Command Line Interface

The command line interface is a teletypewriter (TTY) text interface that requires you to enter commands to use it. The workstation that accesses it must be an ASCII terminal or a personal computer (PC) or other workstation emulating an ASCII terminal.

Before the MSS Server is operational in the network, you usually reach the command line interface over a link through an MSS Server service port in one of the following ways:

- Using TTY through the EIA 232 service port
- Telnetting into the MSS Server through the EIA 232 service port (using SLIP)
- Telnetting into the MSS Server through the 10BASE-T Ethernet service port

After the MSS Server is operational in the ATM network, you can Telnet into the MSS Server over IP to bring up this interface. If one connection to the MSS Server is a Telnet session, the MSS Server can support two connections simultaneously, but each connection must be running a different MSS Server process (such as OPCON and GWCON).

The command line interface provides the following configuring and monitoring functions:

- Login authentication.
- Displaying the status of system processes. This means that the command line interface can show you which processes of the OPCON are currently active. The OPCON processes are the functions of OPCON, for example, *Config*, which is the configuration process, and *GWCON*, which is the most frequently used monitoring process.

The *Talk 6* command brings up the configuration process

The *Talk 5* command brings up the GWCON monitoring process.

From the Config process you can bring up the event logging system (ELS), which displays system error messages.

- Displaying statistics including:
 - Packets forwarded
 - Memory utilization
 - Uptime
 - Last restart or reboot
 - Detailed interface error counters
 - Protocol status (routing tables) and error counters
 - ATM Virtual Circuit Connection statistics
- Controlling the output from a process.
- Stopping the output from a process.

Refer to the *Multiprotocol Switched Services (MSS) Server Interface Configuration and Software User's Guide* and the *Multiprotocol Switched Services (MSS) Configuring Protocols and Features* for a full description of the command line interface.

Configuration Program

The Multiprotocol Switched Services Configuration Program is a standalone, offline program. It is installed in a workstation that is connected to the MSS Server through one of the service ports or through the ATM network. The workstation must be running TCP/IP.

Before the MSS Server is operational in the network, the Multiprotocol Switched Services Configuration Program is usually connected to the MSS Server through a modem or one of the service ports. While the MSS Server is in this state, you cannot use the Communications options of the Configuration Program.

You can create configuration files and download them to the MSS Server in one of the following ways:

- Over the serial link (EIA 232 service port or modem), using TFTP over SLIP
- Over the serial link, using Xmodem configuration files
- Over the Ethernet link, using TFTP

The workstation must be running TCP/IP.

The configuration file that you download over a serial link can provide an IP address and subnet mask to the MSS Server or establish LAN emulation.

After the MSS Server is operational in the network, you can use the Communications Send option of the Configuration Program to send configuration files from the workstation over the network to the MSS Server. If you are using the version of the Configuration Program that is supported by AIX, you can also use the Communications Retrieve option of the Configuration Program to retrieve configuration files from the MSS Server.

The Configuration Program is shipped with the MSS Server and the *Configuration Program User's Guide for Nways Multiprotocol Access, Routing and Switched Services*. Refer to this manual for details about installing and using the Configuration Program to configure the MSS Server.

Web Browser Hypertext Markup Language (HTML) Interface

The Web browser interface is a configurator that is a home page and is accessed by a Web browser from a TCP/IP workstation. Before the MSS Server is operational in the network, you usually use the serial line connection and SLIP or Telnet through the Ethernet service port. After the MSS Server is operational in the network, you can access the MSS Server from a Classical IP workstation in the network.

The MSS Server includes HyperText Transfer Protocol (HTTP) support to allow it to act as a World Wide Web (WWW) server. This allows access to the MSS Server from any HyperText Markup Language (HTML) 3.0 or higher Web browser. The HTML interface can be used for both configuration and monitoring operations.

You need a Web browser that can display clickable images and tables. You can access the Web browser interface using SLIP or IP.

If you give the Web browser the SLIP address, the IP address of the Ethernet service port, one of the configured IP addresses of the MSS Server, or its name (if you use an IP name server), the Web browser interface will come up.

Notes:

1. The configured IP addresses of the MSS Server include the IP addresses of all the LAN emulation clients and Classical IP clients.
2. When using the SLIP interface, do not execute a TFTP to or from the MSS Server.

Refer to the *Multiprotocol Switched Services (MSS) Server Interface Configuration and Software User's Guide* for a full description of the Web browser interface.

Appendix A. Charts

This appendix provides you with the cabling chart and the rack inventory chart. You can use them to plan the installation of the 8210.

Cabling Chart

Fill in the identification information for the MSS Server. Then, mark the box for each connector that you plan to use with an **X**. Label the heavy lines between the boxes with the cable numbers. For example, if the cable is a patch cable, you might identify it as P8. For each termination point, specify the type of device (for example, Distribution Panel). For each room, rack, and connection, write in the correct information. For example, you might write in E210-11-B6 to indicate that the distribution panel is in room E210 of building 11 and that the connection to the patch panel is B6.

Rack Inventory Chart

This chart helps you plan where to place devices within a rack. Follow the instructions on the chart to use it.

IBM 8210 MSS Server Cabling Chart

MSS Unit # _____

Building _____

Location (Room, Rack) _____

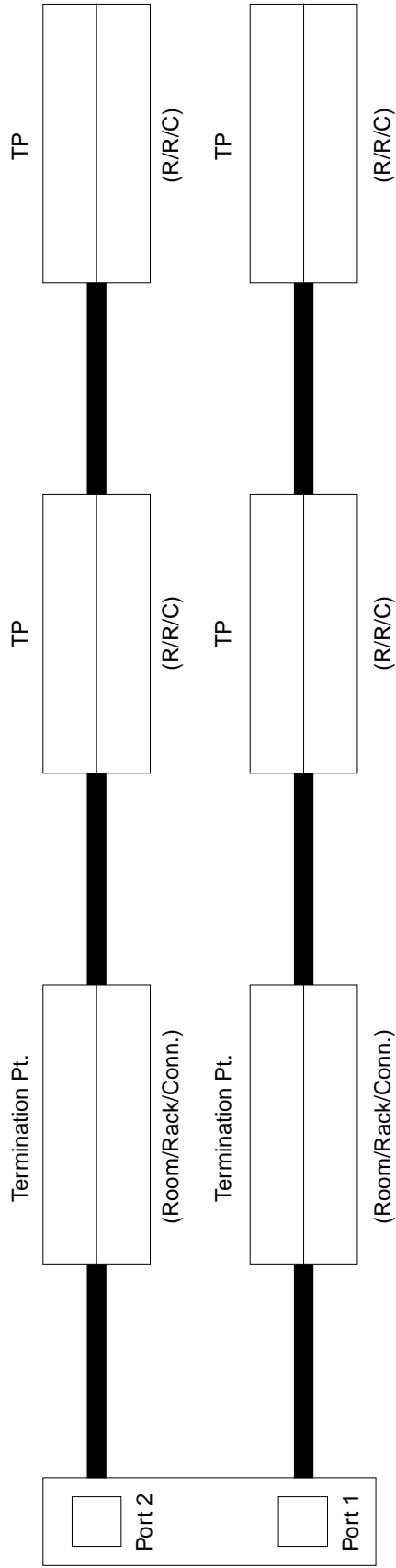

Rack Inventory Chart for the 8210 (Standalone)

Date

Wiring Closet
Number

Rack Number

Planner's
Initials

Rack Diagram

Instructions

Fill out a Rack Inventory Chart for each equipment rack.

1. Enter the wiring closet location number, the equipment rack identification number, and the planner's initials.
2. Use the dimensions below to represent the size of the 8210.
3. Write the unit identification number and component type on each component on the chart.

Example

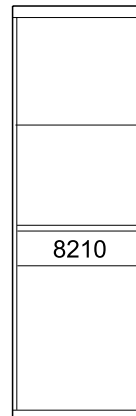

2U
(92.1 mm)
(3.63 in.)

480 mm (18.9 in.)



8210 Dimensions Scaled
to the size of the Rack Diagram

Appendix B. Notices

References in this publication to IBM products, programs, or services do not imply that IBM intends to make these available in all countries in which IBM operates. Any reference to an IBM product, program, or service is not intended to state or imply that only IBM's product, program, or service may be used. Any functionally equivalent product, program, or service that does not infringe any of IBM's intellectual property rights may be used instead of the IBM product, program, or service. Evaluation and verification of operation in conjunction with other products, except those expressly designated by IBM, are the user's responsibility.

IBM may have patents or pending patent applications covering subject matter in this document. The furnishing of this document does not give you any license to these patents. You can send license inquiries, in writing, to the IBM Director of Licensing, IBM Corporation, 500 Columbus Avenue, THORNWOOD NY 10594 USA.

Electronic Emission Notices

Federal Communications Commission (FCC) Statement

This equipment has been tested and found to comply with the limits for a Class A digital device, pursuant to Part 15 of the FCC Rules. These limits are designed to provide reasonable protection against harmful interference when the equipment is operated in a commercial environment. This equipment generates, uses, and can radiate radio frequency energy and, if not installed and used in accordance with the instruction manual, may cause harmful interference to radio communications. Operation of this equipment in a residential area is likely to cause harmful interference, in which case the user will be required to correct the interference at his own expense.

Properly shielded and grounded cables and connectors (IBM part number 55H8694 or its equivalent for the data/fax/voice modem, or IBM part number 72H4447 or equivalent for the data/fax modem) must be used in order to meet the FCC emissions limits. IBM is not responsible for any radio or television interference caused by using other than recommended cables and connectors or by unauthorized changes or modifications to this equipment. Unauthorized changes or modifications to this equipment may cause interference which could void the user's authority to operate this equipment.

This device complies with Part 15 of the FCC Rules. Operation is subject to the following two conditions: (1) this device may not cause harmful interference, and (2) this device must accept any interference received, including interference that may cause undesired operation.

Industry Canada Class A Emission Compliance Statement

This Class A digital apparatus meets all requirements of the Canadian Interference-Causing Equipment Regulations.

Avis de conformité aux normes d'Industrie Canada

Cet appareil numérique de la classe A respecte toutes les exigences du Règlement sur le matériel brouilleur du Canada.

European Union (EU) Mark of Conformity Statement

This product is in conformity with the protection requirements of EU Council Directive 89/336/EEC on the approximation of the laws of the Member States relating to electromagnetic compatibility. IBM cannot accept responsibility for any failure to satisfy the protection requirements resulting from a non-recommended modification of the product, including fitting of non-IBM option cards.

Properly shielded and grounded cables and connectors (IBM part number 72H4447 or equivalent for the data/fax modem) must be used in order to reduce the potential for causing interference to radio and TV communications and to other electrical or electronic equipment. IBM cannot accept responsibility for any interference caused by using other than recommended cables and connectors.

Warning: This is a Class A product. In a domestic environment this product may cause radio interference in which case the user may be required to take adequate measures.

Zulassungsbescheinigung laut dem Deutschen Gesetz über die elektromagnetische Verträglichkeit von Geräten (EMVG) vom 30. August 1995 (bzw. der EMC EG Richtlinie 89/336)

Dieses Gerät ist berechtigt in Übereinstimmung mit dem Deutschen EMVG das EG-Konformitätszeichen - CE - zu führen.

Verantwortlich für die Konformitätserklärung nach Paragraph 5 des EMVG ist die IBM Deutschland Informationssysteme GmbH, 70548 Stuttgart.

Informationen in Hinsicht EMVG Paragraph 3 Abs. (2) 2:

Das Gerät erfüllt die Schutzanforderungen nach EN 50082-1 und EN 55022 Klasse A.
--

EN 55022 Klasse A Geräte müssen mit folgendem Warnhinweis versehen werden:
"Warnung: dies ist eine Einrichtung der Klasse A. Diese Einrichtung kann im Wohnbereich Funkstörungen verursachen; in diesem Fall kann vom Betreiber verlangt werden, angemessene Maßnahmen durchzuführen und dafür aufzukommen."

EN 50082-1 Hinweis:

"Wird dieses Gerät in einer industriellen Umgebung betrieben (wie in EN 50082-2 festgelegt), dann kann es dabei eventuell gestört werden. In solch einem Fall ist der Abstand bzw. die Abschirmung zu der industriellen Störquelle zu vergrößern."

Anmerkung:

Um die Einhaltung des EMVG sicherzustellen sind die Geräte, wie in den IBM Handbüchern angegeben, zu installieren und zu betreiben.

Japanese Voluntary Control Council for Interference (VCCI) Statement

This is a Class A product based on the standard of the Voluntary Control Council for Interference by Information Technology Equipment (VCCI). If this equipment is used in a domestic environment, radio disturbance may arise. When such trouble occurs, the user may be required to take corrective actions.

この装置は、情報処理装置等電波障害自主規制協議会（VCCI）の基準に基づくクラスA情報技術装置です。この装置を家庭環境で使用すると電波妨害を引き起こすことがあります。この場合には使用者が適切な対策を講ずるよう要求されることがあります。

CISPR22 Compliance Statement

This product has been tested and found to comply with the limits for Class A Information Technology Equipment according to CISPR22 / European Standard EN 55022. The limits for Class A equipment were derived for commercial and industrial environments to provide reasonable protection against interference with licensed communication equipment.

Warning: This is a Class A product. In a domestic environment this product may cause radio interference in which case the user may be required to take adequate measures.

Taiwanese Class A Warning Statement

警告使用者：
這是甲類的資訊產品，在居住的環境中使用時，可能會造成射頻干擾，在這種情況下，使用者會被要求採取某些適當的對策。

Trademarks

The following terms are trademarks of the International Business Corporation in the United States and/or other countries:

AIX	Library Reader	Personal System/2
APPN	Nways	PowerPC
AT	Operating System/2	PS/2
IBM	OS/2	RS/6000

Microsoft, Windows, and the Windows 95 logo are trademarks or registered trademarks of Microsoft Corporation.

Other company, product, and service names may be trademarks or service marks of others.

Glossary

This glossary includes terms and definitions from the *IBM Dictionary of Computing* (New York; McGraw-Hill, Inc., 1994).

- The symbol (A) identifies definitions from the *American National Standard Dictionary for Information Systems*, ANSI X3.172-1990, copyright 1990 by the American National Standards Institute (ANSI). Copies can be purchased from the American National Standards Institute, 1430 Broadway, New York, New York 10018.
- The symbol (E) identifies definitions from the ANSI/EIA Standard-440-A, *Fiber Optic Terminology*.
- The symbol (I) identifies definitions from published parts of the *Information Technology Vocabulary*, developed by Subcommittee 1, Joint Technical Committee 1, of the International Organization for Standardization and the International Electrotechnical Commission (ISO/IEC JTC1/SC1).
- The symbol (T) identifies definitions from draft international standards, committee drafts, and working papers being developed by ISO/IEC JTC1/SC1.

The following cross-references are used in this glossary:

Contrast with: This refers to a term that has an opposed or substantively different meaning.

Synonym for: This indicates that the term has the same meaning as a preferred term, which was defined in its correct place in the glossary.

Synonymous with: This is a backward reference from a defined term to all other terms that have the same meaning.

See: This refers the reader to multiple-word terms that have the same last word.

See also: This refers the reader to related terms that have a related, but not synonymous, meaning.

A

active. (1) Able to communicate on the network. (2) Operational. (3) Pertaining to a node or device that is connected or is available for connection to another node or device. (4) Currently transmitting or receiving.

adapter. In a communicating device, a circuit card that, with its associated software and/or microcode, enables the device to communicate over the network.

Adaptive source route transparent bridging (ASRT). This is source route transparent (SRT)

bridging combined with source route to transparent bridging (SR-TB). In this type of bridging, source routed traffic can be converted to transparent bridge format. The conversion is not part of the SRT standard.

address. (1) A character or group of characters that identifies a register, a particular part of storage, or some other data source or destination. (A) (2) To refer to a device or an item of data by its address. (I) (A) (3) In data communication, the unique code assigned to each device or workstation connected to a network.

Address Resolution Protocol (ARP). A protocol that dynamically maps between Internet addresses, baseband adapter addresses, X.25 addresses, and token-ring adapter addresses on a local area network.

IP ARP translates network addresses into hardware addresses. LAN emulation ARP translates LAN destinations into ATM addresses.

addressing. In data communication, the way in which a station selects the station to which it is to send data.

Advanced Peer-to-Peer Networking (APPN). An extension to SNA featuring (a) greater distributed network control that avoids critical hierarchical dependencies, thereby isolating the effects of single points of failure; (b) dynamic exchange of network topology information to foster ease of connection, reconfiguration, and adaptive route selection; (c) dynamic definition of network resources; and (d) automated resource registration and directory lookup. APPN extends the LU 6.2 peer orientation for end-user services to network control and supports multiple LU types, including LU 2, LU 3, and LU 6.2.

agent. In the client-server model, the part of the system that performs information preparation and exchange on behalf of a client or server application.

AIX. Advanced Interactive Executive. See *AIX operating system*.

AIX operating system. IBM's implementation of the UNIX operating system. The RS/6000 system, among others, runs the AIX operating system. See *UNIX operating system*.

ambient noise. In acoustics, the noise associated with a particular environment, usually a composite of sounds from many distant or nearby sources. See also *background noise* and *impulsive noise*.

American National Standard Code for Information Interchange (ASCII). The standard code, using a coded character set consisting of 7-bit coded characters

(8 bits including parity check), used for information interchange among data processing systems, data communication systems, and associated equipment. The ASCII set consists of control characters and graphics characters. (A)

Note: IBM has defined an extension to ASCII code (characters 12–255).

application. (1) The use to which an information processing system is put; for example, a payroll application, an airline reservation application, a network application. (2) A collection of software components used to perform specific types of user-oriented work on a computer.

APPN. Advanced peer-to-peer networking.

ARP. Address Resolution Protocol.

AS. Autonomous system.

ASCII. American Standard Code for Information Interchange.

ASRT. Adaptive source route transparent bridging.

ATM. Asynchronous Transfer Mode, a connection-oriented, high-speed networking technology based on cell switching.

attach. To make a device a part of a network logically.

attaching device. Any device that is physically connected to a network and can communicate over the network.

B

backbone. (1) In a local area network multiple-bridge ring configuration, a high-speed link to which the rings are connected by means of bridges or routers. A backbone can be configured as a bus or as a ring. (2) In a wide area network, a high-speed link to which nodes or data switching exchanges (DSEs) are connected.

background noise. In acoustics, total of all interference sources in a system used to produce, detect, measure, or record a signal, excluding noise produced by the signal itself. See also *ambient noise* and *impulsive noise*.

BAN. Boundary access node.

Basic Input/Output System (BIOS). Code that controls basic hardware operations, such as interactions with diskette drives, hard disk drives, and the keyboard.

BBCM. Bridging Broadcast Manager.

BCM. Broadcast Manager.

BGP-4. Border Gateway Protocol-4.

binary. Pertaining to a system of numbers to the base two; the binary digits are 0 and 1. (A)

binary digit. Synonym for *bit*.

BIOS. Basic Input/Output System.

bit. Either of the digits 0 or 1 when used in the binary numeration system. Synonymous with *binary digit*. (T) See also *byte*.

BNN. Boundary network node.

Border Gateway Protocol-4 (BGP-4). An Internet Protocol (IP) routing protocol used between domains and autonomous systems.

boundary access node (BAN). A router (such as the IBM 6611) that provides its attached LAN-based SNA peripheral nodes direct frame-relay access to a subarea boundary node (such as an IBM 3745 or an IBM 3746 Model 900).

boundary network node (BNN). Synonym for *boundary node*.

boundary node (BN). In SNA, a subarea node with boundary function.

Note: A subarea node may be a boundary node, an intermediate routing node, both, or neither, depending on how it is used in the network.

bridge. (1) An attaching device that connects two LAN segments to allow the transfer of information from one LAN segment to the other. A bridge can connect the LAN segments directly by network adapters and software in a single device, or it can connect network adapters in two separate devices through software and use of a telecommunications link between the two adapters. (2) A functional unit that connects two LANs that use the same logical link control (LLC) procedures but may use the same or different medium access control (MAC) procedures. (T) Contrast with *gateway* and *router*.

Note: A bridge connects networks or systems of the same or similar architectures, whereas a gateway connects networks or systems of different architectures.

bridging. The forwarding of a frame from one local area network segment to another. The destination is based upon the medium access control (MAC) sublayer address encoded in the destination address field of the frame header.

Bridging Broadcast Manager (BBCM). A bridging enhancement which can transform certain types of bridged broadcast frames into unicast frames, reducing the number of packets processed by end stations and interconnection devices while also decreasing network utilization.

broadcast. (1) Transmission of the same data to all destinations. (T) (2) Simultaneous transmission of the same data to more than one destination. (3) A packet delivery system where a copy of a given packet is given to all hosts attached to the network. Broadcast can be implemented in hardware (Ethernet, for example) or software. Contrast with *multicast*.

Broadcast and Unknown Server (BUS). A LAN emulation service component responsible for the delivery of multicast and unknown unicast frames.

Broadcast Manager (BCM). An IBM extension to LAN emulation designed to limit the effects of broadcast frames.

BUS. Broadcast and Unknown Server.

BUS Monitor. A function in the MSS Server that provides a mechanism to pinpoint end users who could be overutilizing the BUS. It can improve network performance by identifying the causes of a possible bottleneck at the BUS.

byte. (1) A string that consists of a number of bits, treated as a unit, and representing a character. (T) (2) A binary character operated upon as a unit and usually shorter than a computer word. (A) (3) A group of 8 adjacent binary digits.

C

C. Celsius.

change management. The process of planning, administering, and distributing changes to network hardware and software components. This network management discipline is commonly accepted as a component of configuration management. See *configuration management*.

CIP. Classical IP.

circuit. One or more conductors through which an electric current can flow.

Classical IP over ATM. Classical IP, an IETF standard that defines how ATM-attached hosts can communicate using IP over ATM.

client. A functional unit that receives shared services from a server. (T)

command. (1) A request for performance of an operation or execution of a program. (2) A character string from a source external to a system that represents a request for system action.

communication link. (1) The assembly of parts of two data terminal equipment that are controlled by a link protocol, and the interconnecting data circuit, that enable data to be transferred from a data source to a data sink. (I) (2) See also *data link*.

community. An administrative relationship between Simple Network Management Protocol (SNMP) entities.

community name. An opaque string of octets identifying a community.

component. Hardware or software that is part of a functional unit.

configuration. (1) The manner in which the hardware and software of an information processing system are organized and interconnected. (T) (2) The devices and programs that make up a system, subsystem, or network. (3) The task of defining the hardware and software characteristics of a system or subsystem. (4) See also *system configuration*.

configuration file. A file that specifies the characteristics of a system device or network related to a specific product.

configuration management. The monitoring and control of information required to identify physical and logical network resources, their states, and their interdependencies. Services include customization, network resource inventory, and assistance to other network management disciplines.

connect. In a LAN, to physically join a cable from a station to an access unit or network connection point. Contrast with *attach*.

connection. (1) In data communication, an association established between functional units for conveying information. (I) (A) (2) In Open Systems Interconnection architecture, an association established by a given layer between two or more entities of the next higher layer for the purpose of data transfer. (T) (3) In TCP/IP, the path between two protocol applications that provides reliable data stream delivery service. In Internet, a connection extends from a TCP application on one system to a TCP application on another system. (4) The path between two protocol functions, usually located in different machines, that provides reliable data delivery service.

control point (CP). A component of a node that manages resources of that node and optionally provides services to other nodes in the network.

conversion. The process of changing from one form of representation to another, for example, to change from decimal representation to binary representation. In bridging, conversion means changing frames from source route format to transparent bridging format.

CPSW. Control Point Switch Module.

D

D-PVLANS. Dynamic Protocol VLANs.

data. (1) A representation of facts, concepts, or instructions in a formalized manner suitable for communication, interpretation, or processing by human or automatic means. (l) (A) (2) Any representations such as characters or analog quantities to which meaning is or might be assigned. (A)

data circuit. (1) A pair of associated transmit and receive channels that provide a means of two-way data communication. (l) (2) See also *physical circuit* and *virtual circuit*. (3)

Notes:

1. Between data switching exchanges, the data circuit can include data circuit-terminating equipment (DCE), depending on the type of interface used at the data switching exchange.
2. Between a data station and a data switching exchange or data concentrator, the data circuit includes the data circuit-terminating equipment at the data station end, and can include equipment similar to a DCE at the data switching exchange or data concentrator location.

data link. (1) The assembly of parts of two data terminal equipment (DTE) devices that are controlled by a link protocol, and the interconnecting data circuit, that enable data to be transferred from a data source to a data sink. (l) (2) Any physical link, such as a wire or a telephone circuit, that connects one or more remote terminals to a communication control unit, or connects one communication control unit with another. (3) The interconnecting data circuit and the link protocol between two or more equipments; it does not include the data source or the data sink.

Note: A telecommunication line is only the physical medium of transmission. A data link includes the physical medium of transmission, the protocol, and associated devices and programs—it is both physical and logical.

dB. Decibel.

dependent logical unit requester. See *dependent LU requester*.

dependent LU requester (DLUR). An APPN end node or an APPN network node that owns dependent LUs, but requests that a dependent LU server provide the SSCP services for those dependent LUs.

destination. Any point or location, such as a node, station, or particular terminal, to which information is to be sent.

device. (1) A mechanical, electrical, or electronic contrivance with a specific purpose. (2) An input/output unit such as a terminal, display, printer, or telephone. See also *attaching device*.

disk. A round, flat, data medium that is rotated in order to read or write data. (T) See also *diskette*.

diskette. A small magnetic disk enclosed in a jacket. (T)

diskette drive. The mechanism used to seek, read, and write data on a diskette.

distribution panel. A wiring board that provides a patch panel function and mounts in a rack. See also *patch panel*.

DLL. Data link layer.

DLUR. Dependent LU requester

DOS. Disk Operating System.

Dynamic Protocol VLANs (D-PVLANS). A dynamically determined subset of the bridge ports. There are many variations, but DPF VLANs operate by learning which ports are actively participating in which virtual LANs. Multicast traffic for this virtual LAN is then forwarded only over those actively participating bridge ports. By reducing the forwarding domain of multicast packets, end stations and interconnection devices have fewer packets to process, and network utilization is decreased.

E

EIA unit. Electronic Industries Association unit.

EIA 232. In data communications, a specification of the Electronic Industries Association (EIA) that defines the interface between data terminal equipment (DTE) and data circuit-terminating equipment (DCE), using serial binary data interchange.

ELAN. Emulated local area network.

Electronic Industries Association (EIA). An organization of electronics manufacturers that advances the technological growth of the industry, represents the views of its members, and develops industry standards.

Electronic Industries Association (EIA) unit. A unit of measure equal to 4.45 cm (1.75 in.).

Emulated local area network (ELAN). A LAN segment implemented with ATM technology.

emulation. (1) The use of a data processing system to imitate another data processing system, so that the imitating system accepts the same data, executes the same programs, and achieves the same results as the imitated system. Emulation is usually achieved by means of hardware or firmware. (T) (2) The use of programming techniques and special machine features to permit a computing system to execute programs written for another system.

enable. To make functional.

enabled. On a LAN, pertaining to an adapter or device that is active, operational, and able to receive frames from the network.

encapsulation. A technique used by layered protocols by which a layer adds header information to the protocol data unit (PDU) from the layer above. In Internet terminology for example, a packet would contain a header from the physical layer, followed by a header from the transport layer (TCP), followed by the application protocol data.

error. A discrepancy between a computed, observed, or measured value or condition and the true, specified, or theoretically correct value or condition. (I) (A) Contrast with *failure* and *fault*.

Ethernet. A 10-Mbps baseband local area network that allows multiple stations to access the transmission medium at will without prior coordination, avoids contention by using carrier sense and deference, and resolves contention by collision detection and transmission. Ethernet uses carrier sense multiple access with collision detection (CSMA/CD).

event. (1) An occurrence or happening. (2) An occurrence of significance to a task; for example the completion of an asynchronous operation, such as an input/output operation.

explorer packet. A packet, generated by the source host that traverses the entire token-ring network gathering information on the possible paths the host might use.

F

F. Fahrenheit.

failure. (1) The termination of the ability of a functional unit to perform its required function. (I) (A) (2) An uncorrected hardware error. Failures are either recoverable or not recoverable by the software or the operator. The operator is always notified when failures occur. Contrast with *error*.

fault. An accidental condition that causes a functional unit to fail to perform its required function. (I) (A)

feature. A part of an IBM product that can be ordered separately by the customer.

fiber. Dielectric material that guides light; waveguide (see *multimode* and *single-mode optical fiber*). See *optical fiber*.

fiber optics. The branch of optical technology concerned with the transmission of radiant power through fibers made of transparent materials such as glass, fused silica, and plastic. (E)

Note: Telecommunication applications of fiber optics use optical fibers. Either a single discrete fiber or a nonspatially aligned fiber bundle can be used for each information channel. Such fibers are often called optical fibers to differentiate them from fibers used in noncommunication applications.

file. A named set of records stored or processed as a unit. (T)

File Transfer Protocol (FTP). The Internet protocol (and program) used to transfer files between hosts. It is an application layer protocol in TCP/IP that uses TELNET and TCP protocols to transfer bulk-data files between machines or hosts.

fixed disk. Synonym for *hard disk*.

fixed disk drive. Synonym for *hard disk drive*.

frame. (1) A data structure that consists of fields, predetermined by a protocol, for the transmission of user data and control data. The composition of a frame, especially the number and types of fields, may vary according to the type of protocol. Synonymous with *transmission frame*. (T) (2) The unit of transmission in some local area networks, including the IBM Token-Ring Network; it includes delimiters, control characters, information, and checking characters. (3) A packet that is transmitted over a serial line or LANs. See also *packet*.

FTP. File Transfer Protocol.

function. A specific purpose of an entity, or its characteristic action. (A)

G

gateway. (1) A functional unit that interconnects two computer networks with different network architectures. A gateway connects networks or systems of different architectures. A bridge interconnects networks or systems with the same or similar architectures. (T) (2) A computer that attaches two or more networks and routes data packets to their destination through those networks. Contrast with *bridge* and *router*. (3) The original Internet term for router or IP router.

H

hard disk. (1) A rigid magnetic disk such as the internal disks used in the system units of personal computers and in external hard disk drives. Synonymous with *fixed disk*. (2) A rigid disk used in a hard disk drive.

Note: The term hard disk is also used loosely in the industry for boards and cartridges containing microchips or bubble memory that simulate the operations of a hard disk drive.

hard disk drive. A stand-alone disk drive that reads and writes data on rigid disks and can be attached to a port on the system unit. Synonymous with *fixed disk drive*, *hard drive*.

hardware. All or part of the physical components of an information processing system, such as computers or peripheral devices. (T) (A)

help. A choice that allows a user to select various kinds of help information.

high-performance routing (HPR). An addition to the Advanced Peer-to-Peer Networking (APPN) architecture that enhances data routing performance and reliability, especially when using high-speed links.

HPR. High-performance routing.

I

IBM Disk Operating System (DOS). A disk operating system based on MS-DOS** that operates with all IBM-compatible personal computers.

ICMP. Internet Control Message Protocol.

IEEE. Institute of Electrical and Electronics Engineers.

ILMI. Interim Local Management Interface, SNMP-based procedures for managing the User-Network Interface (UNI).

impulsive noise. In acoustics, noise of an impulsive nature whose level is determined with a sound level meter set for the dynamic characteristic "impulse."

Institute of Electrical and Electronic Engineers (IEEE). An organization involved in establishing Local Area Network standards.

interface. (1) A shared boundary between two functional units, defined by functional characteristics, signal characteristics, or other characteristics, as appropriate. The concept includes the specification of the connection of two devices having different functions. (T) (2) Hardware, software, or both, that links systems, programs, or devices.

Internet. The largest internet in the world consisting of large national backbone networks and a myriad of regional and campus networks all over the world. The Internet uses the Internet protocol suite. See also *internet*.

Internet Control Message Protocol (ICMP). The protocol used to handle errors and control messages in the Internet Protocol layer. Reports of problems and incorrect datagram destinations are returned to the original datagram source. ICMP is part of the Internet Protocol.

Internet Packet Exchange (IPX). The routing protocol used to connect Novell's servers or any workstation or router that implements IPX with other workstations. Although similar to TCP/IP, it uses different packet formats and terminology. See also *TCP/IP* and *Xerox Network Services (XNS)*.

Internet Protocol (IP). (1) A protocol that routes data through a network or interconnected networks. IP acts as an interface between the higher logical layers and the physical network. However, this protocol does not provide error recovery, flow control, or guarantee the reliability of the physical network. IP is a connectionless protocol. (2) A protocol used to route data from its source to its destination in an Internet environment.

IP. Internet Protocol.

IP address. A 32-bit address assigned to devices or hosts in an IP internet that maps to a physical address. The IP address is composed of a network and host portion.

IPX. Internet Packet Exchange.

J

jumper cable. Synonym for *patch cable*.

K

Kbps. 1000 bits per second.

| **KVA.** Kilovolt-amperes.

L

LAN. Local area network.

LAN emulation (LE, LANE). The MSS Server implements the *LAN Emulation Over ATM: Version 1.0 Specification*, which is widely accepted as the industry standard for multivendor multiprotocol interoperability. LAN emulation protocols allow ATM networks to provide the appearance and function of local area networks like Ethernet and token ring.

LAN emulation client (LEC). A LAN emulation component that represents users of the emulated LAN.

LAN emulation configuration server (LECS). A LAN emulation service component that centralizes and disseminates configuration data.

LAN emulation server (LES). A LAN emulation service component that resolves LAN destinations to ATM addresses.

LANE. LAN emulation.

layer. (1) In network architecture, a group of services that is complete from a conceptual point of view, that is one out of a set of hierarchically arranged groups, and that extends across all systems that conform to the network architecture. (T) (2) In the Open System Interconnection reference model, one of seven conceptually complete, hierarchically arranged groups of services, functions, and protocols that extend across all open systems. (T)

LE. LAN emulation.

LEC. LAN emulation client.

LECS. LAN emulation configuration server.

LES. LAN emulation server.

link. (1) The logical connection between nodes including the end-to-end link control procedures. (2) The combination of physical media, protocols, and programming that connects devices on a network.

| **LIS.** Logical IP subnet.

LLC. Logical link control.

local. Pertaining to a device accessed directly without use of a telecommunication line. Contrast with *remote*.

local area network (LAN). (1) Physical network technology that transfers data at high speed over short distances. (2) A network in which a set of devices are connected to one another for communication and that can be connected to a larger network. See also *token ring* and *Ethernet*. (3) A computer network located on a user's premises within a limited geographical area. Communication within a local area network is not subject to external regulations; however, communication across the LAN boundary may be subject to some form of regulation. (T) Contrast with *wide area network (WAN)* and *metropolitan area network (MAN)*.

location. Any place in which data can be stored. (A)

| **logical IP subnet (LIS).** A Classical IP (CIP) subnet. | It is composed of a CIP ARP Server and the attached | CIP Clients.

logical link. A logical link is a link entity with the property that multiple logical links can be distinguished while they share the use of the same physical media connecting two physical nodes. Examples are 802.2 logical links used on LAN facilities and LAP E logical links on the same point-to-point physical link between two nodes.

logical link control (LLC). (1) The data link control (DLC) LAN sublayer that provides two types of (DLC) operation. The first type is connectionless service, which allows information to be sent and received without establishing a link. The LLC sublayer does not perform error recovery or flow control for connectionless service. The second type is connection-oriented service, which requires the establishment of a link prior to the exchange of information. Connection-oriented service provides sequenced information transfer, flow control, and error recovery. (2) A sublayer of the OSI link layer that defines formats and protocols for exchanging frames between LLC sublayers attached to a local area network. It has provisions that ensure that error-free, nonduplicated, properly ordered frames are delivered to the appropriate data-link user. See also *bridge* and *medium access control (MAC)*.

logical link control (LLC) protocol. In a local area network, the protocol that governs the exchange of transmission frames between data stations independently of how the transmission medium is shared. (T) The LLC protocol was developed by the IEEE 802 committee and is common to all LAN standards.

logical link control (LLC) protocol data unit. A unit of information exchanged between link stations in different nodes. The LLC protocol data unit contains a destination service access point (DSAP) address, a source service access point (SSAP), a control field, and user data. See *logical link control (LLC)*.

logical link control (LLC) sublayer. One of two sublayers of the ISO Open Systems Interconnection data link layer (which corresponds to the SNA data link control layer), proposed for LANs by the IEEE Project 802 Committee on local area networks and the European Computer Manufacturers Association (ECMA). It includes those functions unique to the particular link control procedures that are associated with the attached node and are independent of the medium; this allows different logical link protocols to coexist on the same network without interfering with each other. The LLC sublayer uses services provided by the medium access control (MAC) sublayer and provides services to the network layer.

M

MAC. Medium Access Control, the bottom sublayer of the Data Link layer, which is layer 2 of the ISO model.

MAC. Medium access control.

MAN. Metropolitan area network.

management information base (MIB). A collection of objects that can be accessed by means of a network management protocol, such as Simple Network Management Protocol (SNMP).

management station. The system responsible for managing all, or a portion of, a network. The management station talks to network management agents that reside in the managed node by means of a network management protocol such as Simple Network Management Protocol (SNMP). Synonymous with *network management station (NMS)*.

MB. (1) For processor storage and real and virtual memory, 1048 576 bytes. (2) For disk storage capacity and transmission rates, 1 000 000 bytes.

Mb. Megabit.

Mbps. One million bits per second.

medium access control (MAC). (1) The sublayer of the data link control layer that supports media-dependent functions and uses the services of the physical layer to provide services to the logical link control sublayer. The MAC sublayer includes the medium-access port. See *logical link control (LLC)*.

medium access control (MAC) protocol. (1) In a local area network, the protocol that governs access to the transmission medium, taking into account the topological aspects of the network, in order to enable the exchange of data between data stations. (T) See also *logical link control protocol*. (2) The LAN protocol sublayer of data link control (DLC) protocol that includes functions for adapter address recognition, copying of message units from the physical network, and message unit format recognition, error detection, and routing within the processor.

medium access control (MAC) sublayer. In a local area network, the part of the data link layer that applies a medium access method. The MAC sublayer supports topology-dependent functions and uses the services of the physical layer to provide services to the logical link control sublayer. (T)

memory. All of the addressable storage space in a processing unit and other internal storages that is used to execute instructions. (T)

message. (1) In electronic mail, information transferred as an entity between correspondents. (I) (2) An assembly of characters and sometimes control codes that is transferred as an entity from an originator to one or more recipients. A message consists of two parts: envelope and content. (T)

metropolitan area network (MAN). A network formed by the interconnection of two or more networks which may operate at higher speeds than those networks, may cross administrative boundaries, and may use multiple access methods. (T) Contrast with *local area network (LAN)* and *wide area network (WAN)*.

MIB. (1) Management information base. (2) MIB module.

MIB view. The collection of managed objects, known to the agent, that is visible to a particular community.

migrate. To move to a changed operating environment, usually to a new release or version of a program, system, or device.

mm. Millimeter, millimeters.

modem (modulator/demodulator). (1) A functional unit that modulates and demodulates signals. One of the functions of a modem is to enable digital data to be transmitted over analog transmission facilities. (T) (A) (2) A device that converts digital data from a computer to an analog signal that can be transmitted in a telecommunication line, and converts the analog signal received to data for the computer.

MSS. Multiprotocol Switched Services.

multicast. (1) Transmission of the same data to a selected group of destinations. (T) (2) A special form of broadcast where copies of the packet are delivered to only a subset of all possible destinations. Contrast with *broadcast*.

multimode optical fiber. (1) A graded-index or step-index optical fiber that allows more than one bound mode to propagate. (E) Contrast with *single-mode optical fiber*. (2) An optical fiber waveguide usually characterized by a core diameter of 50 to 100 μm that will allow a large number of modes to propagate.

Multiprotocol Switched Services. A component of IBM's Switched Virtual Networking (SVN) framework.

N

name. An alphanumeric term that identifies a data set, statement, program, or cataloged procedure.

NetBIOS. Network Basic Input/Output System. An operating system interface for application programs used on IBM personal computers that are attached to the IBM Token-Ring Network. See also *BIOS*.

network. (1) An arrangement of nodes and connecting branches. (T) (2) A configuration of data processing devices and software connected for information interchange. (3) A signal path connecting input/output devices to a system. A network can consist of multiple LAN segments connected together with bridging products. (4) The interconnection of two or more subnets.

network management. The process of planning, organizing, and controlling a communications-oriented system.

network management station (NMS). The system responsible for managing a network or a portion of a network. The NMS talks to network management agents, that reside in the managed nodes, by means of a network management protocol. See also *agent*.

NHRP. Next-Hop Routing Protocol.

NMS. Network management station.

noise. In acoustics, any undesired sound.

O

offline. Pertaining to the operation of a functional unit that takes place either independently of, or in parallel with, the main operation of a computer. (T)

Open Shortest Path First (OSPF). Provides intra-domain information transfer for the Internet

Protocol (IP). An alternative to the Routing Information Protocol (RIP), OSPF allows the lowest cost routing defined by the user and handles routing in large regional or corporate networks. It is a link-state routing protocol specified by the IETF; link-state routing protocols scale better than vector-distance routing protocols like RIP.

operating system (OS). Software that controls the execution of programs and that may provide services such as resource allocation, scheduling, input/output control, and data management. Although operating systems are predominantly software, partial hardware implementations are possible. (T)

Operating System/2 (OS/2). A set of programs that control the operation of high-speed large-memory IBM personal computers (such as the IBM Personal System/2 computer, Models 50 and above), providing multitasking and the ability to address up to 16 MB of memory. Contrast with *IBM Disk Operating System (DOS)*.

operation. (1) A defined action, namely, the act of obtaining a result from one or more operands in accordance with a rule that completely specifies the result for any permissible combination of operands. (A) (2) A program step undertaken or executed by a computer; for example, addition, multiplication, extraction, comparison, shift, transfer. The operation is usually specified by the operator part of an instruction. (A) (3) An action performed on one or more data items, such as adding, multiplying, comparing, or moving.

optical cable. A fiber, multiple fibers, or a fiber bundle in a structure built to meet optical, mechanical, and environmental specifications. (E)

optical fiber. Any filament made of dielectric materials that guides light, regardless of its ability to send signals. (E) See also *fiber optics*.

optical fiber cable. Synonym for *optical cable*.

OS. Operating system.

OSPF. Open Shortest Path First.

P

packet. (1) In data communication, a sequence of binary digits, including data and control signals, that is transmitted and switched as a composite whole. (I) (2) Synonymous with *data frame*. Contrast with *frame*.

parallel. (1) Pertaining to a process in which all events occur within the same interval of time, each handled by a separate but similar functional unit; for example, the parallel transmission of the bits of a

computer word along the lines of an internal bus. (T)
(2) Pertaining to concurrent or simultaneous operation of two or more devices or to concurrent performance of two or more activities in a single device. (A)
(3) Pertaining to concurrent or simultaneous occurrence of two or more related activities in multiple devices or channels. (4) Pertaining to the simultaneity of two or more processes. (5) Pertaining to the simultaneous processing of the individual parts of a whole, such as the bits of a character and the characters of a word, using separate facilities for the various parts. (A)
(6) Contrast with *serial*.

parallel port. A port that transmits the bits of a byte in parallel along the lines of the bus, 1 byte at a time, to an I/O device. On a personal computer, it is used to connect a device that uses a parallel interface, such as a dot matrix printer, to the computer. Contrast with *serial port*.

parity. (1) A transmission error-checking scheme in which an extra bit is added to some unit of data, usually a byte, in order to make the total number of one bits even or odd. For the AEA feature, odd, even, mark, space, or no-parity coding is supported. No-parity means that no parity bit is sent or expected. Mark and space mean that the parity position is always set to one or zero, respectively, and that received parity is not checked. (2) The state of being either even-numbered or odd-numbered.

parity (even). A condition when the sum of all of the digits in an array of binary digits is even.

parity (odd). A condition when the sum of all of the digits in an array of binary digits is odd.

patch cable. A length of cable with data connectors at both ends that is normally used to interconnect two sections of building cable at a patch panel or to connect a product to the building cable. Synonymous with *jumper cable*.

patch panel. An organized concentration of cable terminations, usually mounted in a flat panel, that facilitates the interconnection of communication cables.

PC. Personal computer.

PCMCIA. Personal Computer Memory Card International Association.

personal computer (PC). (1) A microcomputer primarily intended for stand-alone use by an individual. (T) (2) A desk-top, floor-standing, or portable microcomputer that usually consists of a system unit, a display monitor, a keyboard, one or more diskette drives, internal fixed-disk storage, and an optional printer. PCs are designed primarily to give independent computing power to a single user and are inexpensively priced for purchase by individuals or small businesses.

Personal Computer Memory Card International Association (PCMCIA). An organization involved in establishing hardware standards that are often associated with miniaturized peripherals.

physical. (1) Pertaining to actual implementation or location as opposed to conceptual content or meaning. (A) (2) Pertaining to the representation and storage of data on a medium such as magnetic disk, or to a description of data that depends on physical factors such as length of data elements, records, or pointers. (A) (3) Contrast with *logical*. (A)

physical circuit. A circuit established without multiplexing. See also *data circuit*. Contrast with *virtual circuit*.

port. (1) An access point for data entry or exit. (2) A connector on a device to which cables for other devices such as display stations and printers are attached. (3) The representation of a physical connection to the link hardware. A port is sometimes referred to as an adapter, however, there can be more than one port on an adapter. A single DLC process can control one or more ports. (4) An abstraction used by transport protocols to distinguish among multiple destinations within a host machine.

problem determination. The process of determining the source of a problem; for example, a program component, a machine failure, telecommunication facilities, user or contractor-installed programs or equipment, an environment failure such as a power loss, or user error.

processor. In a computer, a functional unit that interprets and executes instructions. A processor consists of at least an instruction control unit and an arithmetic and logic unit. (T)

protocol. (1) A set of semantic and syntactic rules that determines the behavior of functional units in achieving communication. (I) (2) In Open Systems Interconnection architecture, a set of semantic and syntactic rules that determine the behavior of entities in the same layer in performing communication functions. (T)

R

rack. A free-standing framework that holds equipment.

rack inventory chart. An IBM Token-Ring Network planning chart indicating the location of the components installed in an equipment rack.

read-only memory (ROM). (1) A storage device in which data, under normal conditions, can only be read.

(T) (2) Memory in which stored data cannot be modified by the user except under special conditions.

receive. To obtain and store data.

reconfiguration. A change made to a given configuration of a computer system; for example, isolating and bypassing a defective functional unit, connecting two functional units by an alternative path. Reconfiguration is effected automatically or manually and can be used to maintain system integrity. (T)

reduced instruction-set computer (RISC). A computer that uses a small simplified set of frequently used instructions for rapid execution.

reference noise. The magnitude of circuit noise that will produce a circuit noise meter reading equal to that produced by ten micromicrowatts of electric power at 1000 cycles per second.

remote. Pertaining to a system, program, or device that is accessed through a telecommunication line. Contrast with *local*.

remove. (1) To take an attaching device off a network. (2) To stop an adapter from participating in data passing on a network.

Request for Comments (RFC). Documents that describe the Internet suite of protocols and related experiments. All Internet standards are written as RFCs.

resource. (1) People, equipment, or material used to perform a task or a project. (2) Any facility of a computing system or operating system required by a job or task, and including main storage, input/output devices, processing unit, data sets, and control or processing programs.

RFC. Request for Comments.

ring. (1) Two or more stations in which information is passed sequentially between active stations, each station in turn examining or copying the information, finally returning it to the originating station. (2) See also *ring network*.

ring network. (1) A network configuration in which devices are connected by unidirectional transmission links to form a closed path. (2) A network in which every node has exactly two branches connected to it and in which there are exactly two paths between any two nodes. (T)

RIP. Routing Information Protocol.

RISC. Reduced instruction-set computer.

ROM. Read-only memory. (A)

route. (1) The path that network traffic uses to get from source to destination. (2) An ordered sequence of nodes and transmission groups (TGs) that represent a path from an origin node to a destination node traversed by the traffic exchanged between them.

router. (1) A computer that determines that path of network traffic flow. The path selection is made from several paths based on information obtained from specific protocols, algorithms that attempt to identify the shortest or best path, and other criteria such as metrics or protocol-specific destination addresses. (2) An attaching device that connects two LAN segments, which use similar or different architectures, at the reference model network layer. Contrast with *bridge* and *gateway*.

routing. The assignment of the path by which a message is to reach its destination.

Routing Information Protocol (RIP). A protocol that provides intra-domain routing information transfer and calculates a route based upon the least number of hops, regardless of link transmission speed. It is a vector-distance routing protocol. It is used by several routing protocols including the Internet Protocol (IP), Internet Packet Exchange (IPX), and Xerox Network Services (XNS).

S

SAP. Service Advertising Protocol.

select. The process of choosing a single symbol or menu item by placing the cursor on it and clicking the mouse button. To select multiple symbols simultaneously, press and hold the Shift key down while clicking on the symbols you want to select.

serial. (1) Pertaining to a process in which all events occur one after the other; for example, serial transmission of the bits of a character according to V24 CCITT protocol. (T) (2) Pertaining to the sequential or consecutive occurrence of two or more related activities in a single device or channel. (A) (3) Contrast with *parallel*.

serial port. On personal computers, a port used to attach devices such as display devices, letter-quality printers, modems, plotters, and pointing devices such as light pens and mice; it transmits data 1 bit at a time. Contrast with *parallel port*.

server. (1) A functional unit that provides shared services to workstations over a network; for example, a file server, a print server, a mail server. (T) (2) In a network, a data station that provides facilities to other stations; for example, a file server, a print server, a mail server. (A) (3) A device, program, or code module on

a network dedicated to providing a specific service to a network.

Service Advertising Protocol (SAP). This protocol provides a mechanism that allows IPX servers on an internet to advertise their services by name and type. Servers using this protocol have their name, service type, and internet address recorded in all file servers running NetWare Version 2.1 (and above). A mechanism is also provided that allows a workstation to broadcast a query to discover the identities of all servers of all types, all servers of a specific type, or the nearest server of a specific type. SAP also provides a mechanism for workstations to query any file server running NetWare to discover the names and addresses of all servers of a specific type.

session. (1) In network architecture, for the purpose of data communication between functional units, all the activities which take place during the establishment, maintenance, and release of the connection. (T)
(2) The period of time during which a user of a terminal can communicate with an interactive system, usually, elapsed time between logon and logoff.

Simple Network Management Protocol (SNMP).
(1) An IP network management protocol that is used to monitor routers and attached networks using MIBs.
(2) A TCP/IP-based protocol for exchanging network management information and outlining the structure for communications among network devices. SNMP is an application layer protocol. Information on devices managed is defined and stored in the application's Management Information Base (MIB).

single-mode optical fiber. An optical fiber in which only the lowest-order bound mode (which can consist of a pair of orthogonally polarized fields) can propagate at the wavelength of interest. (E) Contrast with *multimode optical fiber*.

SLIP. Serial Line IP, an IETF standard for running IP over serial communication links.

SNA. Systems Network Architecture, a networking architecture developed by IBM. SNA has a large base of installed systems.

SNA. Systems Network Architecture.

SNMP. Simple Network Management Protocol.

SNMP agent. As defined in the SNMP architecture, an agent, or an SNMP server, is responsible for performing the network management functions requested by the network management stations.

source route bridging. A bridging method that uses the routing information field in the IEEE 802.5 medium access control (MAC) header of a frame to determine which rings or token-ring segments the frame must

transit. The routing information (RI) field is inserted into the MAC header by the originating (source) node. The information in the routing information field is derived from explorer packets generated by the source host. See *explorer packet*.

source route to transparent (SR-TB). A bridge that connects SR and TB ports.

source routing (SR). A bridging protocol for token-ring LANs. See *source route bridging*.

source-route transparent (SRT). A bridging protocol for LANs specified in the IEEE 802.1d standard. SRT bridges support both source-route and transparent bridging on the same port.

spanning tree. The method by which bridges automatically develop a routing table and update that table in response to changing topography to ensure that there is only one route between any two LANs in the bridged LAN. This method prevents packet looping, where a packet returns in a circuitous route back to the sending router.

SR. Source routing.

SR-TB. Source route to transparent bridging.

SRB. Source routing bridging.

SRT. Source-route transparent.

station. (1) An input or output point of a system that uses telecommunication facilities; for example, one or more systems, computers, terminals, devices, and associated programs at a particular location that can send or receive data over a telecommunication line.
(2) A location in a device at which an operation is performed; for example, a read station.

storage. (1) A functional unit into which data can be placed, in which they can be retained and from which they can be retrieved. (T) (2) The action of placing data into a storage device. (I) (A) (3) A storage device. (A)

Note: The terms storage and memory are sometimes used loosely as synonyms. In a more precise and useful sense, the term memory pertains to the part of storage in which instructions are executed (main storage or execution space) and excludes auxiliary storage devices such as disks, diskettes, mass storage devices, and magnetic tape. The term memory is used primarily in microcomputers and calculators, whereas the term main storage is used primarily in large and intermediate systems.

subnet. Shortened form of *subnetwork*. See *subnetwork*.

subnetwork. Any group of nodes that have a set of common characteristics, such as the same network ID.

switch. Equipment that makes, breaks, or changes the connections between devices in an ATM network.

system. In data processing, a collection of people, machines, and methods organized to accomplish a set of specific functions. (I) (A)

system configuration. A process that specifies the devices and programs that form a particular data processing system.

Systems Network Architecture (SNA). The description of the logical structure, formats, protocols, and operational sequences for transmitting information units through, and controlling the configuration and operation of, networks.

Note: The layered structure of SNA allows the ultimate origins and destinations of information, that is, the end users, to be independent of and unaffected by the specific SNA network services and facilities used for information exchange.

T

TB. Transparent bridging.

TCP. Transmission Control Protocol.

TCP/IP. Transmission Control Protocol/Internet Protocol.

Telnet. In TCP/IP, an application protocol that allows a user at one site to access a remote system as if the user's display station were locally attached. Telnet uses the Transmission Control Protocol as the underlying protocol.

terminal. In data communication, a device, usually equipped with a keyboard and display device, capable of sending and receiving information.

terminal emulation. The capability of a microcomputer or personal computer to operate as if it were a particular type of terminal linked to a processing unit and to access data.

token. (1) In a local area network, the symbol of authority passed successively from one data station to another to indicate the station temporarily in control of the transmission medium. Each data station has an opportunity to acquire and use the token to control the medium. A token is a particular message or bit pattern that signifies permission to transmit. (T) (2) A sequence of bits passed from one device to another along the token ring. When the token has data appended to it, it becomes a frame.

token ring. (1) A network with a ring topology that passes tokens from one attaching device to another; for example, the IBM Token-Ring Network. See also *local area network (LAN)*. (2) A group of interconnected token rings.

topology. The physical or logical arrangement of nodes in a computer network. Examples are ring topology and bus topology.

Transmission Control Protocol (TCP). (1) A communications protocol used in Internet and in any network that follows the U.S. Department of Defense standards for inter-network protocol. TCP provides a reliable host-to-host protocol between hosts in packet-switched communications networks and in interconnected systems of such networks. It assumes that the Internet protocol is the underlying protocol. (2) A transport protocol in the Internet suite of protocols that provides reliable, connection-oriented, full-duplex data stream service.

Transmission Control Protocol/Internet Protocol (TCP/IP). (1) A set of protocols that allow cooperating computers to share resources across a heterogeneous network. (2) A set of communication protocols that support peer-to-peer connectivity functions for both local and wide area networks.

transmission frame. (1) In data transmission, data transported from one node to another in a particular format that can be recognized by the receiving node. In addition to a data or information field, a frame has some kind of delimiter that marks its beginning and end and usually control fields, address information that identifies the source and destination, and one or more check bits that allow the receiver to detect any errors that occur after the sender has transmitted the frame. (2) In synchronous data link control (SDLC), the vehicle for every command, every response, and all information that is transmitted using SDLC procedures. Each frame begins and ends with a flag. (3) In high level data link control (HDLC), the sequence of contiguous bits bracketed by and including opening and closing flag (01111110) sequences. (4) In a token-ring network, a bit pattern containing data that a station has inserted for transmission after capturing a token.

transparent bridging (TB). A method for tying individual local area networks (LANs) together through the medium access control (MAC) level. A transparent bridge keeps the tables that hold MAC addresses so that frames seen by the bridge can be forwarded to another LAN if the tables indicate to do so. This bridging protocol is specified in the IEEE 802.1d standard.

trap. A vital part of the Simple Network Management Protocol (SNMP). A trap is specified data that is sent

by a managed node (agent function) to a management station to report an exception condition.

U

U. Unit. See *Electronic Industries Association (EIA) unit*.

UDP. User Datagram Protocol.

UNIX operating system. An operating system developed by Bell Laboratories that features multiprogramming in a multiuser environment. The UNIX operating system was originally developed for use on minicomputers, but has been adapted for mainframes and microcomputers.

Note: The AIX operating system is IBM's implementation of the UNIX operating system.

User Datagram Protocol (UDP). (1) In TCP/IP, a packet-level protocol built directly on the Internet Protocol layer. UDP is used for application-to-application programs between TCP/IP host systems. (2) A transport protocol in the Internet suite of protocols that provides unreliable, connectionless datagram service. (3) The Internet Protocol that enables an application programmer on one machine or process to send a datagram to an application program on another machine or process. UDP uses the internet protocol (IP) to deliver datagrams.

V

V. Volt.

version. A separately licensed program, based on an existing licensed program, that usually has significant new code or new function.

virtual circuit. (1) A logical connection established between two DTEs. (2) In packet switching, the facilities provided by a network that give the appearance to the user of an actual connection. (T) See also *data circuit*. Contrast with *physical circuit*. (3) In a packet-switching data network, a logical

end-to-end transmission channel—as opposed to a physical connection—that connects X.25 users. Virtual circuits allow physical transmission facilities to be shared by many users simultaneously. (4) Synonym for *virtual connection*.

virtual connection. (1) A connection between two nodes on the network that is established using the transport layer and that provides reliable data between nodes. (2) A logical connection established between two data terminal equipment (DTE) devices. Synonymous with *virtual circuit*.

W

WAN. Wide area network.

wide area network (WAN). (1) A network that provides communication services to a geographic area larger than that served by a local area network or a metropolitan area network, and that may use or provide public communication facilities. (T) (2) A data communications network designed to serve an area of hundreds or thousands of miles; for example, public and private packet-switching networks and national telephone networks. Contrast with *local area network (LAN)* and *metropolitan area network (MAN)*.

workstation. (1) A functional unit at which a user works. A workstation often has some processing capability. (T) (2) Personal desktop computer consisting of a monitor, keyboard, and central processing unit.

write. To make a permanent or transient recording of data in a storage device or on a data medium. (I) (A)

X

Xerox Network Services (XNS). A Xerox Network Services protocol. This term collectively describes the suite of internet protocols developed by the Xerox Corporation. Although similar to TCP/IP protocols, XNS uses different packet formats and terminology. See also *IPX*.

XNS. Xerox Network Services.

Index

A

- access methods
 - Data/Fax Modem 2-7
 - Multiprotocol Switched Services Configuration Program 4-3
 - Voice/Data/Fax Modem 2-7
 - Web browser interface 4-4
- access to the MSS Server 4-1
- accessing
 - file transfer 3-2
 - MIBs 2-9
- acoustic characteristics 3-3
- address
 - ATM 2-7
 - ESI 2-7
 - MAC 2-7
- APPN support 2-5
- ATM (asynchronous transport protocol) address 2-7
- ATM Control Point Switch Module 3-2
- ATM Forum-compliant LAN emulation service 2-3
- ATM virtual interfaces 2-5

B

- bridging and routing support 2-4
- Bridging Broadcast Manager (BBCM) 2-5
- bridging, SNMP 2-8
- BUS monitor 2-3
- BUS performance 2-5

C

- cabling 3-5
- cabling chart A-1
- CD-ROM
 - installation xii
 - Library Reader xii
 - MSS Server publications xi
- CD-ROM publications xi
- change management 3-2
- changes since last edition xii
- Classical IP over ATM 2-4
- clearance, service 3-3
- command line interface 4-2
- community name 2-8
- configuration and monitoring tools 4-1
- configuration program 3-2, 4-2
- Control Point Switch Module—code level 3-2
- CPSW—code level 3-2

D

- Data/Fax Modem 2-7
- depth of the 8210 3-2
- Dynamic Protocol VLANs (D-PVLANs) 2-5

E

- electrical requirements 3-2
- ELS 4-2
- environment for installation 3-2
- environmental specifications 3-3
- ESI address 2-7
- event logging system (ELS) 4-2

F

- FDDI support 2-2, 2-6
- FDDI to ATM support 2-6
- features
 - 8210 PCMCIA hard disk 2-7
 - Data/Fax Modem 2-7
 - hardware 2-7
 - PCMCIA modem 1-1
 - Voice/Data/Fax Modem 2-7
- file transfer 3-2
- functions of the MSS Server
 - APPN support 2-5
 - ATM Forum-compliant LAN emulation service 2-3
 - ATM virtual interfaces 2-5
 - bridging and routing support 2-4
 - Bridging Broadcast Manager 2-5
 - BUS monitor 2-3
 - Classical IP over ATM 2-4
 - descriptions of 2-2
 - Dynamic Protocol VLANs 2-5
 - enhanced LAN emulation broadcast management 2-3
 - FDDI to ATM support 2-6
 - IBM LAN emulation service 2-2
 - introduction to 1-1
 - list of 2-1
 - Next Hop Routing Protocol support 2-6
 - Quality of Service 2-6
 - Redundant ARP Server support 2-6
 - Redundant Default IP Gateway 2-6
 - Routing and Bridging support 2-6
 - Super VLAN support 2-4

G

- GWCON 4-2

H

hard disk 2-7
hardware features 2-7
hardware requirements 3-1
height of the 8210 3-2
HTML interface 4-4

I

IBM LAN emulation service 2-2
installation, CD-ROM xii

L

LAN emulation
 BUS monitor 2-3
 description of 2-2, 2-3
 enhanced broadcast management 2-3
 enhanced functions of 2-3
 manageability 2-3
 performance 2-3
 security 2-3

M

MAC (media access control) address 2-7
MIB (management information block)
 community name 2-8
 contents 2-9
 obtaining 2-9
modem, PCMCIA 1-1, 2-7
monitoring process for the command line
 (GWCON) 4-2
MSS Server library ix
Multiprotocol Switched Services (MSS) Server Module
 CPSW—code level 3-2
Multiprotocol Switched Services Configuration
 Program 4-2, 4-3

N

network management using SNMP 2-8
network topology planning 3-6
Next-Hop Routing Protocol support 2-2, 2-6
noise emission values 3-3
notices B-1

P

PCMCIA hard disk 2-7
PCMCIA modem 1-1, 2-7
physical planning 3-1
physical specifications 3-2
physical, electrical, and environmental
 specifications 3-2

placement options 3-1
planning for network topology 3-6
power requirements 3-3
publications
 CD-ROM xi
 Library Reader xii

Q

Quality of Service (QoS) 2-2, 2-6

R

rack inventory chart A-1
rack-shelf placement 3-1
record keeping 3-6
Redundant ARP Server support 2-6
Redundant Default IP Gateway function 2-6
related publications vii
requirements
 cabling 3-5
 CPSW code level for the A-MSS Server Module 3-2
 for installation: physical, electrical, and
 environmental 3-2
 hardware and software for the configuration
 program 3-2
 requirements, power 3-3
Routing and Bridging support 2-6
routing support 2-4

S

service clearance 3-3
SNMP
 management 2-8
 MIB contents 2-9
software and configuration change management 4-1
space requirements 3-3
standards-based bridging and routing support 2-4
Super VLAN 2-4
SuperELAN 2-2

T

tabletop placement 3-1
talk 5 4-2
talk 6 4-2
tools for configuration and monitoring 4-1
trademarks B-4

V

Voice/Data/Fax Modem 2-7

W

Web browser interface 4-4
web sites for MSS Server information xii
who should read this guide vii
width of the 8210 3-2

Tell Us What You Think!

Multiprotocol Switched Services (MSS) Server Introduction and Planning Guide Publication No. GC30-3820-02

We hope you find this publication useful, readable, and technically accurate, but only you can tell us! Your comments and suggestions will help us improve our technical publications. Please take a few minutes to let us know what you think by completing this form. If you are in the U.S.A., you can mail this form postage free or fax it to us at 1-800-253-3520. Elsewhere, your local IBM branch office or representative will forward your comments or you may mail them directly to us.

Overall, how satisfied are you with the information in this book?	Satisfied	Dissatisfied
	<input type="checkbox"/>	<input type="checkbox"/>

How satisfied are you that the information in this book is:	Satisfied	Dissatisfied
Accurate	<input type="checkbox"/>	<input type="checkbox"/>
Complete	<input type="checkbox"/>	<input type="checkbox"/>
Easy to find	<input type="checkbox"/>	<input type="checkbox"/>
Easy to understand	<input type="checkbox"/>	<input type="checkbox"/>
Well organized	<input type="checkbox"/>	<input type="checkbox"/>
Applicable to your task	<input type="checkbox"/>	<input type="checkbox"/>

Specific comments or problems:

Please tell us how we can improve this book:

Thank you for your comments. If you would like a reply, provide the necessary information below.

Name

Address

Company or Organization

Phone No.



Fold and Tape

Please do not staple

Fold and Tape



NO POSTAGE
NECESSARY
IF MAILED IN THE
UNITED STATES

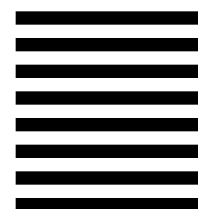

BUSINESS REPLY MAIL

FIRST-CLASS MAIL PERMIT NO. 40 ARMONK, NEW YORK

POSTAGE WILL BE PAID BY ADDRESSEE

Design & Information Development
Dept. CGF/Bldg. 656
International Business Machines Corporation
PO BOX 12195
RESEARCH TRIANGLE PARK NC 27709-9990



Fold and Tape

Please do not staple

Fold and Tape



Printed in the United States of America
on recycled paper containing 10%
recovered post-consumer fiber.

GC30-3820-02

